

STAHL Fräswerkzeuge

STEEL Milling Tools

ACIER Fraises





Starke Schneiden für die Stahlbearbeitung

Die Hartbearbeitung im Werkzeug- und Formenbau ist eine anspruchsvolle Disziplin. Gehärtete Werkzeugstähle werden immer häufiger benötigt und setzen die verwendeten Werkzeuge durch enorme Vorschübe und Schnittgeschwindigkeiten hohen Temperaturen aus. Um trotz der hohen Beanspruchung eine wirtschaftliche und prozesssichere Produktion zu gewährleisten, eignen sich nur Werkzeuge allererster Güte.

Zecha Fräser für die Stahlbearbeitung erfüllen

durch das Zusammenspiel von Hartmetall, Geometrie und Beschichtung hohe Qualitätsansprüche. Absolute Präzision und Rundlaufgenauigkeit, Durchmesser und Formgenauigkeit der Werkzeuge sind ein Muss.

Das umfangreiche Katalogprogramm bietet Kugel-, Torus- und Schaffräser von Durchmesser 0,2 mm bis 30,0 mm. Für die Bearbeitung von gehärteten Stählen bis 65 HRC wurden die Premium-Werkzeugserien 581H und 583H für anspruchsvolle

Applikationen entwickelt. Abgerundet wird dieses Angebot durch spezielle Werkzeuglösungen, die den Anforderungen des Kunden angepasst sind.

In unseren Fräserien für Stahl spiegeln sich annähernd 50 Jahre Erfahrung in der Entwicklung und Fertigung von hochpräzisen Werkzeugen. Bekannt für kompromisslose Qualität erfüllen diese Fräser in Bezug auf Präzision, Schnittgeschwindigkeit und Standzeiten auch die höchsten Ansprüche.

Strong flutes for steel machining

Hard machining in tool and mould making is a demanding discipline. Hardened tool steels are increasingly in demand and enormous feed rates and cutting speeds subject the tools employed to high temperatures. In face of these high demands, only tools of the highest possible quality are able to ensure an economical and process-safe production.

Zecha mills for steel machining provide a blend of carbide, geometry and coating to meet the highest

quality demands. Absolute precision, concentric accuracy, diameter and dimensional exactness of the tools are a must.

The extensive catalogue range offers ball nose end mill, corner radius mill and end mill cutters in diameters spanning 0.2 mm to 30.0 mm. The premium tool series 581 H and 583 H were developed for demanding applications like the machining of hardened steels up to 65 HRC. The range is rounded off by special tool solutions

matched to customer requirements.

Our cutter series for steel is the result of almost half a century of development and manufacture of high precision tools. Synonymous with uncompromising quality these mill cutters fulfil the highest demands for precision, cutting speed and service life.

Solides dents pour l'usinage de l'acier

L'usinage des métaux durs dans la fabrication d'outils et de moules est une discipline exigeante. Les acier trempés pour outils sont de plus en plus souvent nécessaires et les outils utilisés sont soumis à de hautes températures en raison des énormes vitesses d'avance et de coupe. Afin de garantir, malgré ces fortes contraintes, une production économique et une sécurité de processus, seuls ne conviennent que des outils de toute première qualité.

Les fraises Zecha pour l'usinage de l'acier, grâce

à la combinaison métal dur, géométrie et revêtement, remplissent ces hautes exigences de qualité. Précision et concentricité absolues, diamètre et précision de forme des outils sont indispensables.

L'abondant programme du catalogue offre des fraises sphériques, des fraises toriques et des fraises à queue en diamètres de 0,2 mm jusqu'à 30,0 mm. Pour l'usinage d'aciers trempés jusqu'à une dureté de 65 HRC on a mis au point la série d'outils Premium 581H et 583H pour applications

de haute exigence. Cette offre est complétée par des solutions spéciales d'outils adaptées aux exigences du client.

Dans notre série de fraises pour l'acier se reflètent presque 50 ans d'expérience dans la recherche et la fabrication d'outils de haute précision. Ces fraises, connues pour leur qualité sans compromis, remplissent les plus hautes exigences en ce qui concerne la précision, la vitesse de coupe et la durabilité.



Inhaltsverzeichnis

Table of content

Sommaire

Seite
Page
Page

Seite
Page
Page

Symbole Symbols Symboles	06
Übersicht Fräser Overview end mills Aperçu fraises	08
Platz für Ihre Notizen Notes De la place pour vos notices	51
Schnittdatenempfehlungen Cutting data recommendations Valeurs de coupe recommandées	52
Garantierte Qualität Quality warranty Qualité garantie	54
Produktwelt Product world Univers des produits	56
Allgemeine Hinweise General instructions Consignes générales	58

Kugelfräser Ball nose end mills Fraises sphériques

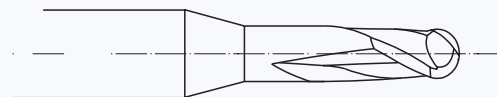

Schneiden Flutes Dents	max. HRC max. HCR max. HCR	Material Material Matériau	Serie Series Série	
2	58	EZ 44	580, 581	14+15
2	65	EZ 22	581H	16
2	65	EZ 44	591, 592	20+21
	45	EZ 22	593	22
	65	EZ 22	593H	23
4	65	EZ 22	597B	24



Seite
Page
Page

Seite
Page
Page

Torusfräser
End mills with corner radius
Fraises toriques

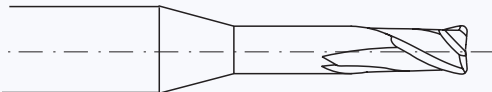

Schneiden Flutes Dents	max. HRC max. HCR max. HCR	Material Material Matériau	Serie Series Série	
2	58	EZ 44	582, 583	25+26
2	65	EZ 22	583H	27
2	58	EZ 44	584, 585	32+33
4	62	EZ 44	586	34
4	62	EZ 44	587	36
3	52	EZ 44	594	38
4	62	EZ 22	594H	39
4	52	EZ 44	595	40
3	65	EZ 22	595H	41
4	65	EZ 22	597T	42
	58		598T	44

Schaftfräser
End mills
Fraises à queue

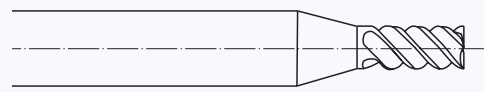

Schneiden Flutes Dents	max. HRC max. HCR max. HCR	Material Material Matériau	Serie Series Série	
2	40	EZ 21	532	45
3	40	EZ 21	533	46
4	40	EZ 21	534	47
4+6+8	58	EZ 22	588	48
4+6+8	65	EZ 22	588H	49
4	58	EZ 22	589	50

Symbole Symbols Symboles

Einsatzempfehlung Symbols for usage recommendations Symboles pour recommandations d'emploi



Geeignet für Werkstoffe bis zum angegebenen Härtewert
Designed for materials up to the hardness stated
Adapté pour des matériaux jusqu'à la dureté indiquée



Zur Bearbeitung von Wolframkupfer
For the machining of tungsten copper
Pour l'usinage du tungstène cuivre



Zur Bearbeitung von Kupfer
For the machining of copper
Pour l'usinage du cuivre



Zur Bearbeitung von Aluminium
For the machining of aluminium
Pour l'usinage de l'aluminium



Zur Bearbeitung von Titan
For the machining of titanium
Pour l'usinage du titane



Schruppbearbeitung
Roughing operation
Dégrossissage



Hochgeschwindigkeitsbearbeitung
Designed for HSC machining
Adapté à l'usinage UGV



Für 3D Bearbeitung geeignet
Suitable for 3D machining
Approprié pour usinage 3D



Zur Bearbeitung von NE-Metallen
For the machining of non-ferrous metals
Pour l'usinage de métaux non-ferreux



Für Naßbearbeitung gut geeignet
Well suitable for wet processing
Bien approprié pour l'usinage mouillé



Schlichten
Finishing
Finition



Vorschlichten
Pre-finishing
Pré-finition

Symbole für Werkzeugeigenschaften Symbols for tool attributes Symboles pour les propriétés des outils



Eine Schneide
One flute
Une dent



Zwei Schneiden
Two flutes
Deux dents



Drei Schneiden
Three flutes
Trois dents



Vier Schneiden
Four flutes
Quatre dents



Sechs Schneiden
Six flutes
Six dents



Acht Schneiden
Eight flutes
Huit dents



Werkzeuge mit höchster Fertigungspräzision im μ -Bereich
Tools with optimum accuracy within the μ -range
Outils avec une précision maximale, proche du micron



Werkzeuge mit Diamant-Beschichtung
Tools with diamond coating
Outils avec revêtement diamant



Werkzeuge mit angepasster Beschichtung
Tools with coating adapted to tool application
Outils avec revêtement adapté à l'application d'outil



Werkzeuge mit ALDURA-Beschichtung für Hartbearbeitung
Tools with ALDURA coating for hard machining
Outils avec revêtement ALDURA pour usinage d'ur



Werkzeuge mit polierten Schneiden und Spankammern
Tools with polished flutes and chipping spaces
Avec dents et chambres de copeaux polies



Werkzeuge mit leichtschneidender Geometrie
Tools with easy-cutting geometry
Outils avec géométrie de coupe facile

















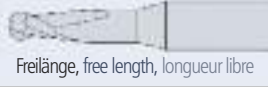









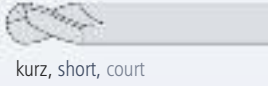



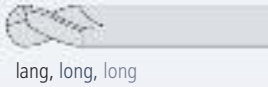



Werkzeuge mit hoher Schneidkantenstabilität
Tools with highly stable flutes
Outils avec une grande stabilité des dents





Übersicht Kugelfräser

Overview Ball nose end mills

Aperçu Fraises sphériques

HSC-Bearbeitung im Formenbau, Solid carbide processing in mould making, Usinage HSC dans la fabrication de moules

Serie	Seite	Bezeichnung	Anwendung	Werkzeugeigenschaften	Beschichtung
Series	Page	Description	Application	Tool attributes	Coating
Série	Page	Déscription	Utilisation	Propriétés des outils	Revêtement
580	14	 kurz, short, court		  Zylinderschaft h4 Cylinder shaft h4 Queue cylindrique h4	
581	15	 Freilänge, free length, longueur libre		 	
581 H	16	 Freilänge, free length, longueur libre		  	
591	20	 kurz, short, court		 zentrumschneidend cutting to centre coupant au centre	
592	21	 lang, long, long			
593	22	 Freilänge, free length, longueur libre		 zentrumschneidend, Lollypop 270° cutting to centre, Lollypop 270° coupant au centre, Lollypop 270°	
593 H	23	 Freilänge, free length, longueur libre		 zentrumschneidend, Lollypop 270° cutting to centre, Lollypop 270° coupant au centre, Lollypop 270°	
597 B	24	 Freilänge, free length, longueur libre		 ungleiche Zahnteilung & Drallsteigung uneven helix & pitch pas inégal des dents & pas de l'hélice	

HM	Schneidenlänge	Zähne	Ø Schaft	Ø Fräser	< 1000 N/mm ²	1000 - 1400 N/mm ²	Edelstahl	Ni-Cr-Legierung	Aluminium	Kupfer	Messing	Titan	Guss	Kunststoffe
Carbide grade	Cutting length	Teeth	Ø Shaft	Ø End mills	Stahl, Steel, Acier	Stahl, Steel, Acier	Stainless steel	Ni-Cr-Alloy	Aluminium	Copper	Brass	Titanium	Cast	Plastics
Métal dur	Longueur de coupe	Dents	Ø Queue	Ø Fraises			Acier inoxydable	Alliage Ni-Cr	Aluminium	Cuivre	Laiton	Titane	Fonte	Plastiques
EZ44	1,1-2 x D		6,0 - 12,0	0,3 - 12,0	1	3	2	3			3	2	2	2
			6,0 - 12,0	0,5 - 12,0										
EZ22	1,1 x D		4,0 - 8,0	0,2 - 8,0	1	1		2					3	
EZ44	2 x D		3,0 - 20,0	0,5 - 20,0	1	1	3	3						
EZ22	2,5 x D		6,0 - 12,0	3,0 - 12,0	1	2	3	3				3	3	3
					1	2					3	3	3	
EZ22	1,1 x D		4,0 - 6,0	2,0 - 6,0	1	1		2					3	

- 1 = **optimal** (optimale Anwendung mit max. Ausnutzung Preis-/Leistungsverhältnis)
 2 = **gut** (wird empfohlen)
 3 = **bedingt** (kann verwendet werden, eingeschränkte Werkzeug-Funktion/-Lebensdauer)
- 1 = **optimal** (optimum application with maximum value for money)
 2 = **good** (is recommended)
 3 = **restricted** (can be used, restricted tool function/service life)
- 1 = **optimal** (emploi optimal avec rendement maximum par son rapport qualité/prix)
 2 = **bon** (recommandé)
 3 = **utilisation limitée** (peut être utilisé, fonction et durée de vie de l'outil limitées)









Übersicht Torusfräser

Overview end mills with corner radius

Aperçu Fraises toriques

HSC-Bearbeitung im Formenbau, Solid carbide processing in mould making, Usinage HSC dans la fabrication de moules

Serie	Seite	Bezeichnung	Anwendung	Werkzeugeigenschaften	Beschichtung	
Series	Page	Description	Application	Tool attributes	Coating	
Série	Page	Déscription	Utilisation	Propriétés des outils	Revêtement	
582+ 584	25	kurz, short, court				
	32					
583+ 585	26	Freilänge, free length, longueur libre			 	
	33				Zylinderschaft h4 Cylinder shaft h4 Queue cylindrique h4	
583 H	27	Freilänge, free length, longueur libre			 	
586	34	kurz, short, court				
587	36	lang, long, long			optimierte Beschichtung optimised coating revêtement optimisé	
594	38	Freilänge, free length, longueur libre				
594 H	39	Freilänge, free length, longueur libre				
595	40	Freilänge, free length, longueur libre				
595 H	41	Freilänge, free length, longueur libre				
597 T	42	Freilänge, free length, longueur libre				
598 T	44	Freilänge, free length, longueur libre				

HM	Schneidenlänge	Zähne	Ø Schaft	Ø Fräser	< 1000 N/mm ²	1000 - 1400 N/mm ²	Edelstahl	Ni-Cr-Legierung	Aluminium	Kupfer	Messing	Titan	Guss	Kunststoffe
Carbide grade	Cutting length	Teeth	Ø Shaft	Ø End mills	Stahl, Steel, Acier	Stahl, Steel, Acier	Stainless steel	Ni-Cr-Alloy	Aluminium	Copper	Brass	Titanium	Cast	Plastics
Métal dur	Longueur de coupe	Dents	Ø Queue	Ø Fraises	Stahl, Steel, Acier	Stahl, Steel, Acier	Acier inoxydable	Alliage Ni-Cr	Aluminium	Cuivre	Laiton	Titane	Fonte	Plastiques
EZ44	1,3-2 x D		6,0	0,5 - 6,0	1	3	2	3			3	2	2	2
			6,0	0,6 - 6,0										
EZ22	1,1 x D		4,0 - 8,0	0,2 - 8,0	1	1		2					3	
EZ44	2 x D		3,0 - 20,0	0,5 - 20,0	1	3	2	3			3	2	2	2
EZ44	0,3 x D		6,0 - 20,0	6,0 - 20,0	1	3								
EZ22			6,0 - 16,0	6,0 - 16,0	3	1								
EZ44	0,3 x D		6,0 - 12,0	4,0 - 12,0	2		2	3	3	3	3	3		2
EZ22	0,4 - 0,8 x D		4,0 - 12,0	1,0 - 12,0	1	1		3				3		
EZ22	1,1 x D		4,0 - 12,0	2,0 - 12,0	1	1		2					3	
EZ22	2 x D		6,0 - 16,0	6,0 - 16,0	1	1	2	3			3	3	3	3

1 = optimal (optimale Anwendung mit max. Ausnutzung Preis-/Leistungsverhältnis)
 2 = gut (wird empfohlen)
 3 = bedingt (kann verwendet werden, eingeschränkte Werkzeug-Funktion/-Lebensdauer)
 1 = optimal (optimum application with maximum value for money)
 2 = good (is recommended)
 3 = restricted (can be used, restricted tool function/service life)

















1 = optimal (emploi optimal avec rendement maximum par son rapport qualité/prix)
 2 = bon (recommandé)
 3 = utilisation limitée (peut être utilisé, fonction et durée de vie de l'outil limitées)

Übersicht Schaftfräser

Overview End mills

Aperçu Fraises à queue

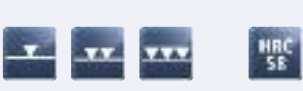
HSC-Bearbeitung im Formenbau, Solid carbide processing in mould making, Usinage HSC dans la fabrication de moules

Serie	Seite	Bezeichnung	Anwendung	Werkzeugeigenschaften	Beschichtung
Series	Page	Description	Application	Tool attributes	Coating
Série	Page	Déscription	Utilisation	Propriétés des outils	Revêtement
532	45				
533	46			 zentrumschneidend cutting to centre coupant au centre	unbeschichtet uncoated non revêtu
534	47				
588	48			 Zwei Schneiden zum Zentrum Two flutes cutting to centre Deux dents à coupe au centre	
588 H	49			 Zwei Schneiden zum Zentrum Two flutes cutting to centre Deux dents à coupe au centre	
589	50			 Zwei Schneiden zum Zentrum Two flutes cutting to centre Deux dents à coupe au centre	

HM	Schneidenlänge	Zähne	Ø Schaft	Ø Fräser	< 1000 N/mm ²	1000 - 1400 N/mm ²	Edelstahl	Ni-Cr-Legierung	Aluminium	Kupfer	Messing	Titan	Guss	Kunststoffe
Carbide grade	Cutting length	Teeth	Ø Shaft	Ø End mills	Stahl, Steel, Acier	Stahl, Steel, Acier	Stainless steel	Ni-Cr-Alloy	Aluminium	Copper	Brass	Titanium	Cast	Plastics
Métal dur	Longueur de coupe	Dents	Ø Queue	Ø Fraises			Acier inoxydable	Alliage Ni-Cr	Aluminium	Cuivre	Laiton	Titane	Fonte	Plastiques
EZ21	2-4 x D		3,0 - 12,0	1,0 - 12,0	2		2		2	1	2	3	2	1
														
														
EZ22	2 x D		4,0 - 20,0	3,0 - 20,0	1	2	3	3				3	3	3
					1	1		3			3	3	3	
														
EZ22	2,5 x D		6,0 - 32,0	3,0 - 32,0	1	3	2	3			3	2	2	2

1 = **optimal** (optimale Anwendung mit max. Ausnutzung Preis-/Leistungsverhältnis)
 2 = **gut** (wird empfohlen)
 3 = **bedingt** (kann verwendet werden, eingeschränkte Werkzeug-Funktion/-Lebensdauer)

1 = **optimal** (optimum application with maximum value for money)
 2 = **good** (is recommended)
 3 = **restricted** (can be used, restricted tool function/service life)

1 = **optimal** (emploi optimal avec rendement maximum par son rapport qualité/prix)
 2 = **bon** (recommandé)
 3 = **utilisation limitée** (peut être utilisé, fonction et durée de vie de l'outil limitées)

580

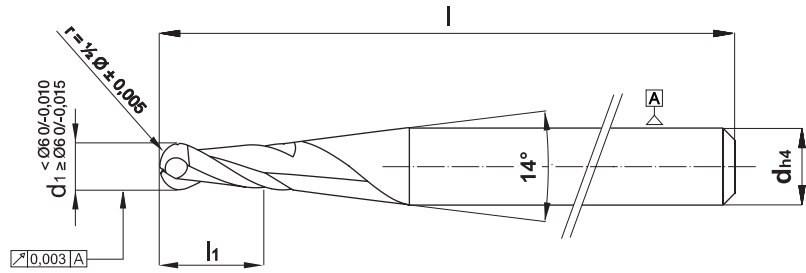
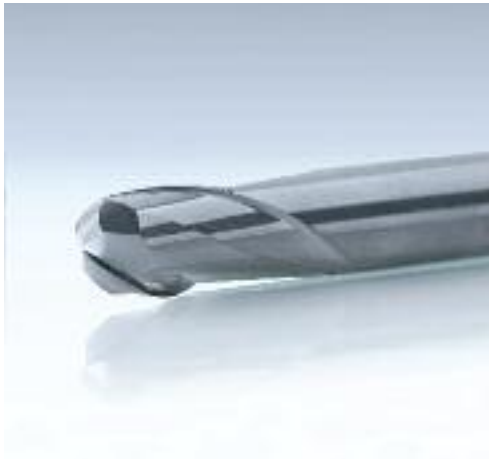

VHM-Kugelfräser für die HSC-Bearbeitung im Formenbau

- Kurze Ausführung
- HM-Sorte: EZ 44
- Hochpräziser Zylinderschaft
- Feinstgeschliffene Schneiden
- Auch gut geeignet zur Bearbeitung von Edelstahl, Guss, Kunststoffe
- Bis 45 HRC zum Schruppen geeignet

Solid carbide ball nose end mill for HSC milling in mould making

- Short design
- Carbide grade: EZ 44
- Highly precise cylinder shaft
- Finest ground flutes
- Also well suited for the processing of stainless steel, cast iron, plastics
- Up to 45 HRC suitable for roughing

Fraise sphériques en carbure monobloc pour l'usinage HSC dans la fabrication de moules

- Modèle court
- Sorte de métal dur: EZ 44
- Queue cylindrique de haute précision
- Dents à poli très fin
- Convient aussi bien pour l'usinage d'acier inox, de fonte, de plastiques
- Convient pour dégrossir jusqu'à 45 HRC

Bestell-Nr. order no N° référence	d ₁	r	l ₁	d	l
580.0030	0,3	0,15	0,6	6,0	64
580.0040	0,4	0,20	0,8	6,0	64
580.0050	0,5	0,25	1,0	6,0	64
580.0060	0,6	0,30	1,2	6,0	64
580.0080	0,8	0,40	1,6	6,0	64
580.0100	1,0	0,50	2,0	6,0	64
580.0120	1,2	0,60	2,4	6,0	64
580.0140	1,4	0,70	2,8	6,0	64
580.0150	1,5	0,75	3,0	6,0	64
580.0160	1,6	0,80	3,2	6,0	64
580.0180	1,8	0,90	3,6	6,0	64
580.0200	2,0	1,00	4,0	6,0	64
580.0250	2,5	1,25	5,0	6,0	64
580.0300	3,0	1,50	6,0	6,0	64
580.0400	4,0	2,00	6,0	6,0	64
580.0500	5,0	2,50	8,0	6,0	64
580.0500XL	5,0	2,50	8,0	6,0	81
580.0600	6,0	3,00	8,0	6,0	64
580.0600XL	6,0	3,00	8,0	6,0	81
580.0800	8,0	4,00	10,0	8,0	105
580.1000	10,0	5,00	12,0	10,0	105
580.1200	12,0	6,00	14,0	12,0	105

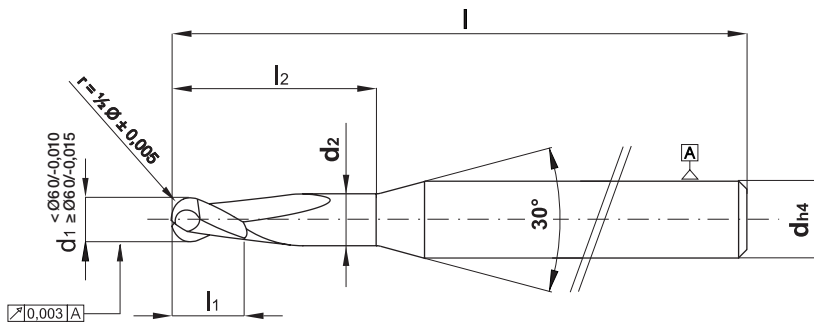
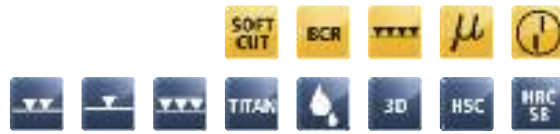

Bestell-Nr. order no N° référence	d ₁	d ₂	r	l ₁	l ₂	d	l
581.0050.0250					2,5		
581.0050.0500	0,5	0,45	0,25	1,0	5,0	6,0	64
581.0060.0300					3,0		
581.0060.0600	0,6	0,55	0,30	1,2	6,0	6,0	64
581.0080.0400					4,0		
581.0080.0800	0,8	0,75	0,40	1,6	8,0	6,0	64
581.0100.0500					5,0		
581.0100.1000					10,0		
581.0100.1500	1,0	0,95	0,50	2,0	15,0	6,0	64
581.0100.2000					20,0		
581.0120.0600					6,0		
581.0120.1200	1,2	1,15	0,60	2,4	12,0	6,0	64
581.0140.0700					7,0		
581.0140.1400	1,4	1,35	0,70	2,8	14,0	6,0	64
581.0150.0750					7,0		
581.0150.1000					10,0		
581.0150.1500	1,5	1,45	0,75	3,0	15,0	6,0	64
581.0150.2000					20,0		
581.0160.0800					8,0		
581.0160.1600	1,6	1,55	0,80	3,2	16,0	6,0	64
581.0180.0900					9,0		
581.0180.1800	1,8	1,75	0,90	3,6	18,0	6,0	64
581.0200.1000					10,0		
581.0200.1500					15,0		
581.0200.2000	2,0	1,92	1,00	4,0	20,0	6,0	64
581.0200.2500					25,0		
581.0250.1250					12,5		
581.0250.2000	2,5	2,42	1,25	5,0	20,0	6,0	64
581.0300.1500					15,0		
581.0300.2500	3,0	2,90	1,50	6,0	25,0	6,0	64
581.0400.1500					15,0		
581.0400.1500	4,0	3,90	2,00	6,0	15,0	6,0	64
581.0500.1800					18,0		
581.0500.3000	5,0	4,90	2,50	8,0	30,0	6,0	81
581.0600.1800					18,0		
581.0600.3000	6,0	5,90	3,00	8,0	30,0	6,0	81
581.0800.2400					24,0		
581.0800.2400	8,0	7,80	4,00	10,0	24,0	8,0	105
581.1000.3000					30,0		
581.1000.3000	10,0	9,80	5,00	12,0	30,0	10,0	105
581.1200.3600					36,0		
581.1200.3600	12,0	11,80	6,00	14,0	36,0	12,0	105

VHM-Kugelfräser für die HSC-Bearbeitung im Formenbau

- Mit Freilänge
- HM-Sorte: EZ 44
- Hochpräziser Zylinderschaft
- Feinstgeschliffene Schneiden
- Auch gut geeignet zur Bearbeitung von Edelstahl, Guss, Kunststoffe
- Bis 45 HRC zum Schruppen geeignet

Solid carbide ball nose end mill for HSC milling in mould making

- With free length
- Carbide grade: EZ 44
- Highly precise cylinder shaft
- Finest ground flutes
- Also well suited for the processing of stainless steel, cast iron, plastics
- Up to 45 HRC suitable for roughing

Fraise sphériques en carbure monobloc pour l'usinage HSC dans la fabrication de moules

- Avec longueur libre
- Sorte de métal dur: EZ 44
- Queue cylindrique de haute précision
- Dents à poli très fin
- Convient aussi bien pour l'usinage d'acier inox, de fonte, de plastiques
- Convient pour dégrossir jusqu'à 45 HRC

581H

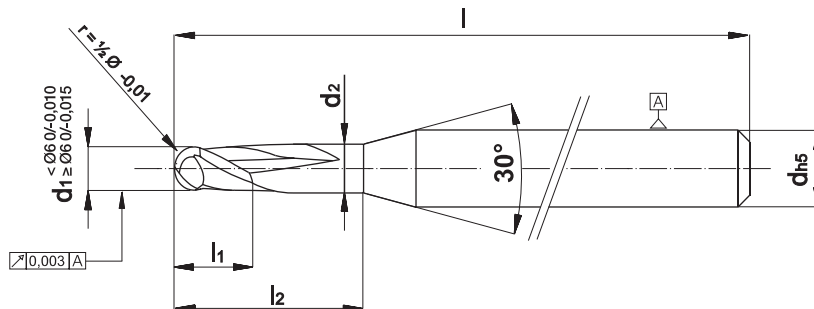
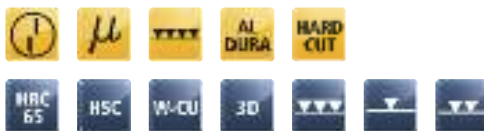

VHM-Kugelfräser für die HSC-Bearbeitung im Formenbau

- Mit Freilänge
- HM-Sorte: EZ 22
- Feinstgeschliffene Schneiden
- Stabile Schneidkante
- Auch gut geeignet zur Bearbeitung von Ni-Cr-Legierungen
- Cobalt-Chrom

Solid carbide ball nose end mill for HSC milling in mould making

- With free length
- Carbide grade: EZ 22
- Finest ground flutes
- Robust flute
- Also well suited for the processing of Ni-Cr alloys
- Cobalt-Chrome

Fraise sphériques en carbure monobloc pour l'usinage HSC dans la fabrication de moules

- Avec longueur libre
- Sorte de métal dur: EZ 22
- Dents à poli très fin
- Taillant résistant
- Convient aussi bien pour l'usinage d'alliages NiCr
- Cobalt-Chrome

Bestell-Nr. order no N° référence	d ₁	d ₂	r	l ₁	l ₂	d	l
581H020.010.006		0,20			0,6		
581H020.010.010	0,2	0,20	0,10	0,3	1,0	4,0	53
581H020.010.015		0,18			1,5		
581H020.010.020		0,18			2,0		
581H030.015.010	0,3	0,30	0,15	0,7	1,0	4,0	53
581H030.015.020		0,27			2,0		
581H030.015.030		0,27			3,0		
581H030.015.040		0,27			4,0		
581H030.015.050		0,27			5,0		
581H040.020.010	0,4	0,35	0,20	0,7	1,0	4,0	53
581H040.020.020					2,0		
581H040.020.030					3,0		
581H040.020.040					4,0		
581H040.020.050					5,0		
581H040.020.060					6,0		
581H040.020.070					7,0		
581H050.025.013	0,5	0,45	0,25	0,7	1,3	4,0	53
581H050.025.025					2,5		
581H050.025.035					3,5		
581H050.025.045					4,5		
581H050.025.065					6,5		
581H050.025.085	8,5						
581H050.025.100	10,0						
581H060.030.025	0,6	0,55	0,30	0,7	2,5	4,0	53
581H060.030.035					3,5		
581H060.030.045					4,5		
581H060.030.065					6,5		
581H060.030.085					8,5		
581H060.030.100					10,0		
581H060.030.115	11,5						
581H080.040.020	0,8	0,75	0,40	1,0	2,0	4,0	53
581H080.040.050					5,0		
581H080.040.080					8,0		
581H080.040.100					10,0		
581H080.040.120					12,0		
581H080.040.140					14,0		
581H080.040.160					16,0		



581H

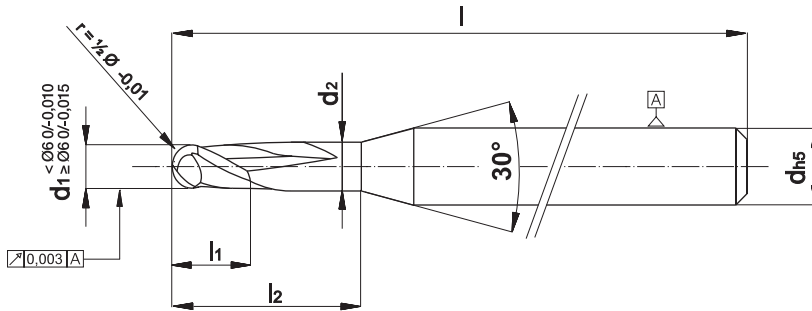

Bestell-Nr. order no N° référence	d ₁	d ₂	r	l ₁	l ₂	d	l
581H100.050.025					2,5		
581H100.050.030					3,0		
581H100.050.040					4,0		
581H100.050.050					5,0		
581H100.050.060					6,0		
581H100.050.070					7,0		
581H100.050.080					8,0		
581H100.050.090	1,0	0,95	0,50	1,5	9,0	4,0	53
581H100.050.100					10,0		
581H100.050.110					11,0		
581H100.050.120					12,0		
581H100.050.140					14,0		
581H100.050.160					16,0		
581H100.050.200					20,0		
581H100.050.250					25,0		
581H120.060.030					3,0		
581H120.060.050					5,0		
581H120.060.080					8,0		
581H120.060.100	1,2	1,15	0,60	1,5	10,0	4,0	53
581H120.060.120					12,0		
581H120.060.150					15,0		
581H120.060.180					18,0		
581H140.070.040					3,5		
581H140.070.060					6,0		
581H140.070.100					10,0		
581H140.070.120	1,4	1,35	0,70	1,5	12,0	4,0	53
581H140.070.150					15,0		
581H140.070.200					20,0		
581H150.075.040					4,0		
581H150.075.060					6,0		
581H150.075.080					8,0		
581H150.075.100					10,0		
581H150.075.120	1,5	1,45	0,75	1,5	12,0	4,0	62
581H150.075.150					15,0		
581H150.075.200					20,0		
581H150.075.250					25,0		
581H160.080.060					6,0		
581H160.080.080					8,0		
581H160.080.120	1,6	1,54	0,80	1,8	12,0	4,0	62
581H160.080.160					16,0		
581H160.080.200					20,0		
581H180.090.060					6,0		
581H180.090.080					8,0		
581H180.090.120	1,8	1,74	0,90	2,0	12,0	4,0	62
581H180.090.160					16,0		
581H180.090.200					20,0		

VHM-Kugelfräser für die HSC-Bearbeitung im Formenbau

- Mit Freilänge
- HM-Sorte: EZ 22
- Feinstgeschliffene Schneiden
- Stabile Schneidkante
- Auch gut geeignet zur Bearbeitung von Ni-Cr-Legierungen
- Cobalt-Chrom

Solid carbide ball nose end mill for HSC milling in mould making

- With free length
- Carbide grade: EZ 22
- Finest ground flutes
- Robust flute
- Also well suited for the processing of Ni-Cr alloys
- Cobalt-Chrome

Fraise sphériques en carbure monobloc pour l'usinage HSC dans la fabrication de moules

- Avec longueur libre
- Sorte de métal dur: EZ 22
- Dents à poli très fin
- Taillant résistant
- Convient aussi bien pour l'usinage d'alliages NiCr
- Cobalt-Chrome

Siehe auch Folgeseite
See also next page
Voir aussi page suivante

581H

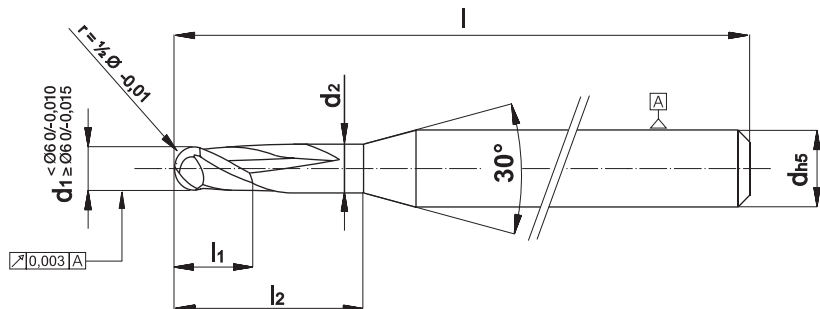
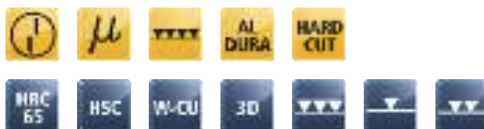

VHM-Kugelfräser für die HSC-Bearbeitung im Formenbau

- Mit Freilänge
- HM-Sorte: EZ 22
- Feinstgeschliffene Schneiden
- Stabile Schneidkante
- Auch gut geeignet zur Bearbeitung von Ni-Cr-Legierungen
- Cobalt-Chrom

Solid carbide ball nose end mill for HSC milling in mould making

- With free length
- Carbide grade: EZ 22
- Finest ground flutes
- Robust flute
- Also well suited for the processing of Ni-Cr alloys
- Cobalt-Chrome

Fraise sphériques en carbure monobloc pour l'usinage HSC dans la fabrication de moules

- Avec longueur libre
- Sorte de métal dur: EZ 22
- Dents à poli très fin
- Taillant résistant
- Convient aussi bien pour l'usinage d'alliages NiCr
- Cobalt-Chrome

Bestell-Nr. order no N° référence	d ₁	d ₂	r	l ₁	l ₂	d	l
581H200.100.030					3,0		
581H200.100.040					4,0		
581H200.100.050					5,0		
581H200.100.060					6,0		
581H200.100.080					8,0		
581H200.100.100					10,0		
581H200.100.120					12,0		
581H200.100.140	2,0	1,95	1,00	2,5	14,0	4,0	62
581H200.100.160					16,0		
581H200.100.180					18,0		
581H200.100.200					20,0		
581H200.100.220					22,0		
581H200.100.240					24,0		
581H200.100.250					25,0		
581H250.125.080					8,0		
581H250.125.120					12,0		
581H250.125.160					16,0		
581H250.125.200	2,5	2,42	1,25	2,8	20,0	4,0	62
581H250.125.230					23,0		
581H250.125.250					25,0		
581H300.150.045					4,5		62
581H300.150.060					6,0		62
581H300.150.080					8,0		62
581H300.150.090					9,0		62
581H300.150.120					12,0		62
581H300.150.150					15,0		62
581H300.150.160					16,0		62
581H300.150.180	3,0	2,90	1,50	3,5	18,0	6,0	62
581H300.150.200					20,0		62
581H300.150.250					25,0		62
581H300.150.270					27,0		62
581H300.150.300					30,0		62
581H300.150.330					33,0		75
581H300.150.360					36,0		75
581H400.200.100					10,0		62
581H400.200.150					15,0		62
581H400.200.200					20,0		62
581H400.200.250	4,0	3,90	2,00	4,5	25,0	6,0	62
581H400.200.300					30,0		62
581H400.200.350					35,0		75
581H500.250.100					10,0		62
581H500.250.125					12,5		62
581H500.250.150					15,0		62
581H500.250.180					18,0		62
581H500.250.200	5,0	4,90	2,50	5,5	20,0	6,0	62
581H500.250.250					25,0		62
581H500.250.300					30,0		62
581H500.250.350					35,0		75

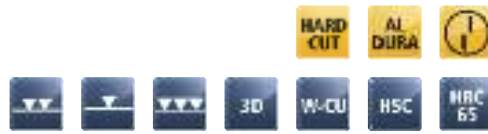

581H

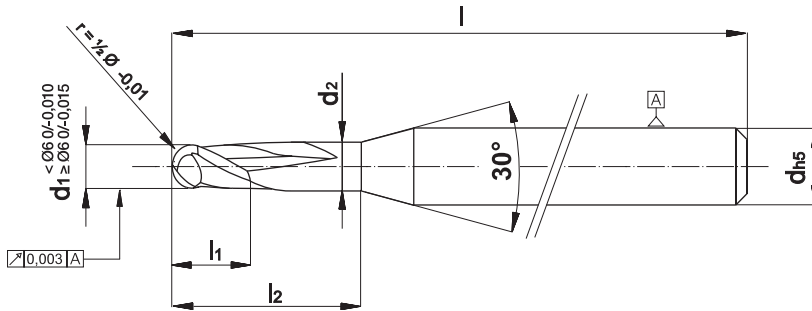

Bestell-Nr. order no N° référence	d ₁	d ₂	r	l ₁	l ₂	d	l
581H600.300.100					10,0		62
581H600.300.150					15,0		62
581H600.300.180					18,0		62
581H600.300.200	6,0	5,90	3,00	6,5	20,0	6,0	62
581H600.300.250					25,0		62
581H600.300.300					30,0		62
581H600.300.350					35,0		75
581H800.400.240	8,0	7,90	4,00	8,5	24,0	8,0	75
581H800.400.400					40,0		75

VHM-Kugelfräser für die HSC-Bearbeitung im Formenbau

- Mit Freilänge
- HM-Sorte: EZ 22
- Feinstgeschliffene Schneiden
- Stabile Schneidkante
- Auch gut geeignet zur Bearbeitung von Ni-Cr-Legierungen
- Cobalt-Chrom

Solid carbide ball nose end mill for HSC milling in mould making

- With free length
- Carbide grade: EZ 22
- Finest ground flutes
- Robust flute
- Also well suited for the processing of Ni-Cr alloys
- Cobalt-Chrome

Fraise sphériques en carbure monobloc pour l'usinage HSC dans la fabrication de moules

- Avec longueur libre
- Sorte de métal dur: EZ 22
- Dents à poli très fin
- Taillant résistant
- Convient aussi bien pour l'usinage d'alliages NiCr
- Cobalt-Chrome

591

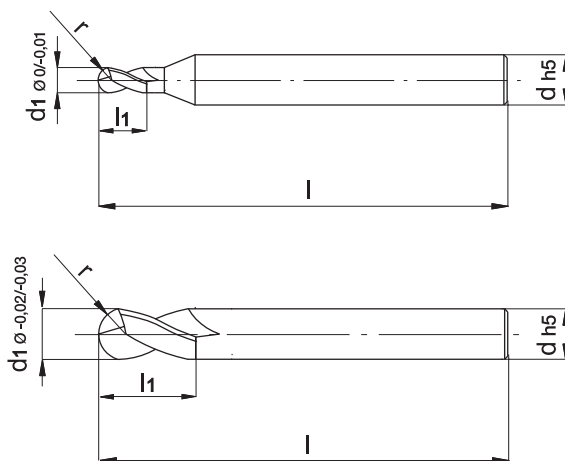

VHM-Kugelfräser für die HSC-Bearbeitung im Formenbau

- Kurze Ausführung
- HM-Sorte: EZ 44
- Zentrumschneidend
- Auch gut geeignet zur Bearbeitung von Guss
- Bedingt geeignet zur Bearbeitung von Edelstahl, Ni-Cr-Legierungen, Titan
- Bis 58 HRC zum Schruppen geeignet

Solid carbide ball nose end mill for HSC milling in mould making

- Short design
- Carbide grade: EZ 44
- Cutting to centre
- Also well suited for the processing of cast iron
- Partial suitability for the milling of stainless steel, Ni-Cr alloys, titanium
- Up to 58 HRC suitable for roughing

Fraise sphériques en carbure monobloc pour l'usinage HSC dans la fabrication de moules

- Modèle court
- Sorte de métal dur: EZ 44
- Coupe au centre
- Convient aussi bien pour l'usinage de la fonte
- Convient sous condition pour l'usinage de l'acier inox, des alliages NiCr, du titane
- Convient pour dégrossir jusqu'à 58 HRC

Bestell-Nr. order no N° référence	d ₁	l ₁	d	h ₅	l
591.005	0,5	1,0	3,0		40
591.010	1,0	2,5	3,0		40
591.015	1,5	3,0	3,0		40
591.020	2,0	4,0	3,0		40
591.025	2,5	5,0	3,0		40
591.030	3,0	6,0	4,0		50
591.035	3,5	7,0	4,0		50
591.040	4,0	8,0	4,0		60
591.050	5,0	10,0	5,0		60
591.060	6,0	12,0	6,0		60
591.070	7,0	14,0	8,0		70
591.080	8,0	16,0	8,0		70
591.100	10,0	20,0	10,0		70
591.120	12,0	24,0	12,0		90
591.160	16,0	32,0	16,0		90
591.200	20,0	40,0	20,0		90

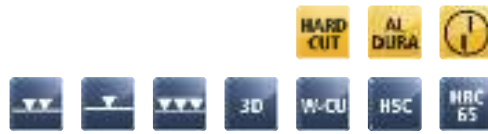

HARD
CUT

AL
DURA



592

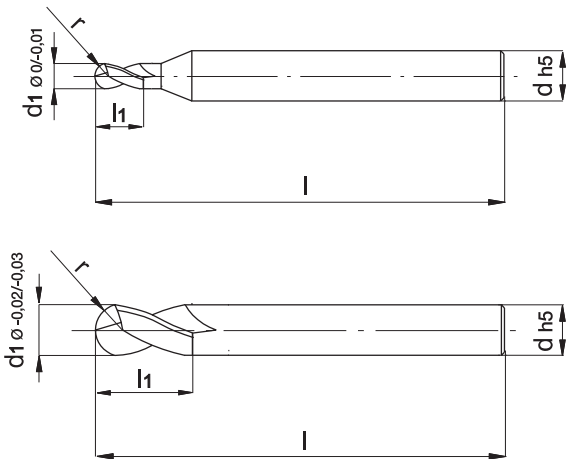

Bestell-Nr. order no N° référence	d ₁	l ₁	d	l
592.005	0,5	1,0	3,0	70
592.010	1,0	2,5	3,0	70
592.015	1,5	3,0	3,0	70
592.020	2,0	4,0	3,0	70
592.025	2,5	5,0	3,0	70
592.030	3,0	6,0	4,0	80
592.035	3,5	7,0	4,0	80
592.040	4,0	8,0	4,0	90
592.050	5,0	10,0	5,0	90
592.060	6,0	12,0	6,0	105
592.070	7,0	14,0	8,0	105
592.080	8,0	16,0	8,0	105
592.100	10,0	20,0	10,0	120
592.120	12,0	24,0	12,0	120
592.160	16,0	32,0	16,0	160
592.200	20,0	40,0	20,0	160

VHM-Kugelfräser für die HSC-Bearbeitung im Formenbau

- Lange Ausführung
- HM-Sorte: EZ 44
- Zentrumschneidend
- Auch gut geeignet zur Bearbeitung von Guss
- Bedingt geeignet zur Bearbeitung von Edelstahl, Ni-Cr-Legierungen, Titan
- Bis 58 HRC zum Schruppen geeignet

Solid carbide ball nose end mill for HSC milling in mould making

- Long design
- Carbide grade: EZ 44
- Cutting to centre
- Also well suited for the processing of cast iron
- Partial suitability for the milling of stainless steel, Ni-Cr alloys, titanium
- Up to 58 HRC suitable for roughing

Fraise sphériques en carbure monobloc pour l'usinage HSC dans la fabrication de moules

- Modèle long
- Sorte de métal dur: EZ 44
- Coupe au centre
- Convient aussi bien pour l'usinage de la fonte
- Convient sous condition pour l'usinage de l'acier inox, des alliages NiCr, du titane
- Convient pour dégrossir jusqu'à 58 HRC

593

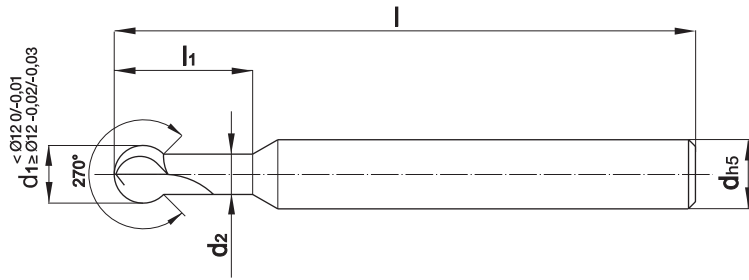
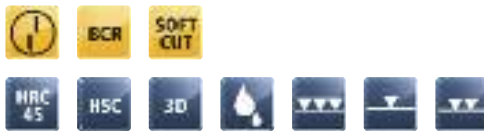

VHM-Kugelfräser für die HSC-Bearbeitung im Formenbau

- Mit Freilänge
- HM-Sorte: EZ 22
- Zentrumschneidend
- 270° Schneidbereich zur Bearbeitung von Hinterschnidungen
- Bedingt geeignet zum Schruppen

Bestell-Nr. order no N° référence	d ₁	d ₂	l ₁	d	l
593.030	3,0	2,1	7,0	6,0	60
593.040	4,0	2,8	9,0	6,0	60
593.050	5,0	3,5	12,0	6,0	60
593.060	6,0	4,3	15,0	8,0	70
593.080	8,0	5,7	21,0	10,0	70
593.100	10,0	7,0	25,0	12,0	70
593.120	12,0	8,5	30,0	12,0	90

Solid carbide ball nose end mill for HSC milling in mould making

- With free length
- Carbide grade: EZ 22
- Cutting to centre
- 270° cutting area for the milling of undercuts
- Partial suitability for roughing

Fraise sphériques en carbure monobloc pour l'usinage HSC dans la fabrication de moules

- Avec longueur libre
- Sorte de métal dur: EZ 22
- Coupe au centre
- Zone de coupe de 270° pour les contredépouilles
- Convient sous condition pour dégrossir



593H

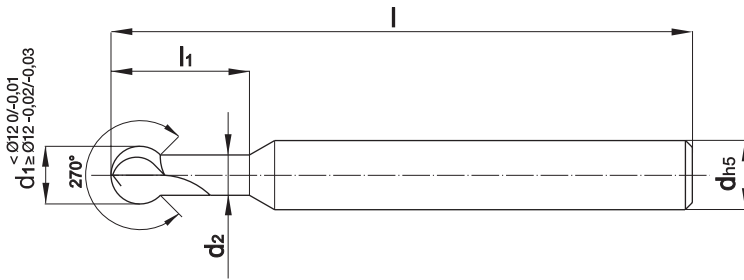

Bestell-Nr. order no N° référence	d ₁	d ₂	l ₁	d	l
593H030	3,0	2,1	7,0	6,0	60
593H040	4,0	2,8	9,0	6,0	60
593H050	5,0	3,5	12,0	6,0	60
593H060	6,0	4,3	15,0	8,0	70
593H080	8,0	5,7	21,0	10,0	70
593H100	10,0	7,0	25,0	12,0	70
593H120	12,0	8,5	30,0	12,0	90

VHM-Kugelfräser für die HSC-Bearbeitung im Formenbau

- Mit Freilänge
- HM-Sorte: EZ 22
- Zentrumschneidend
- 270° Schneidbereich zur Bearbeitung von Hinterschnidungen

Solid carbide ball nose end mill for HSC milling in mould making

- With free length
- Carbide grade: EZ 22
- Cutting to centre
- 270° cutting area for the milling of undercuts

Fraise sphériques en carbure monobloc pour l'usinage HSC dans la fabrication de moules

- Avec longueur libre
- Sorte de métal dur: EZ 22
- Coupe au centre
- Zone de coupe de 270° pour les contredépouilles

597B

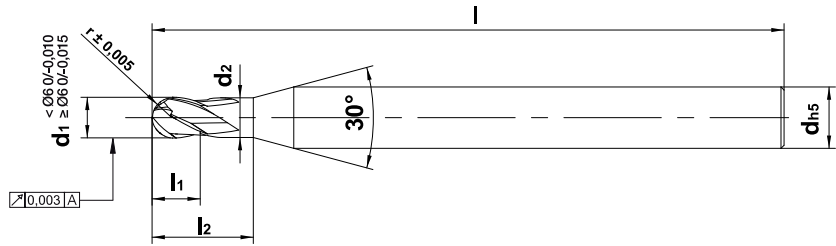
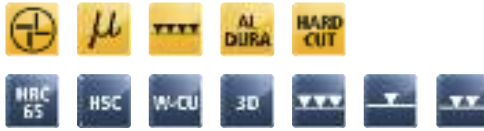

VHM-Kugelfräser für die HSC-Bearbeitung im Formenbau

- Mit Freilänge
- HM-Sorte: EZ 22
- Ungleiche Zahnteilung und Drallsteigung
- Zwei Schneiden zum Zentrum
- Auch gut geeignet zur Bearbeitung von Ni-Cr-Legierungen

Solid carbide ball nose end mill for HSC milling in mould making

- With free length
- Carbide grade: EZ 22
- Uneven pitch and uneven helix
- Two flutes to the centre
- Also well suited for the processing of Ni-Cr alloys

Fraise sphériques en carbure monobloc pour l'usinage HSC dans la fabrication de moules

- Avec longueur libre
- Sorte de métal dur: EZ 22
- Pas inégal de dents et d'hélice
- Deux dents à coupe au centre
- Convient aussi bien pour l'usinage des alliages NiCr

Bestell-Nr. order no N° référence	d ₁	d ₂	r	l ₁	l ₂	d	l
597.B4.200.100.060					6,0		
597.B4.200.100.080					8,0		
597.B4.200.100.100	2,0	1,95	1,0	2,5	10,0	4,0	62
597.B4.200.100.120					12,0		
597.B4.400.200.100					10,0		
597.B4.400.200.150	4,0	3,90	2,0	4,5	15,0	6,0	62
597.B4.400.200.200					20,0		
597.B4.600.300.100					10,0		
597.B4.600.300.150	6,0	5,90	3,0	6,5	15,0	6,0	62
597.B4.600.300.180					18,0		



582

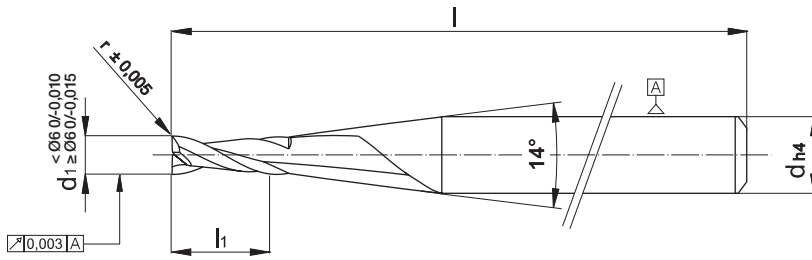

Bestell-Nr. order no N° référence	d ₁	r	l ₁	d	l
582.0050.005	0,5	0,05	1,0	6,0	64
582.0060.005	0,6	0,05	1,2	6,0	64
582.0080.005	0,8	0,05	1,6	6,0	64
582.0100.010	1,0	0,10	2,0	6,0	64
582.0120.010	1,2	0,10	2,4	6,0	64
582.0140.010	1,4	0,10	2,8	6,0	64
582.0150.010	1,5	0,10	3,0	6,0	64
582.0160.010	1,6	0,10	3,2	6,0	64
582.0180.010	1,8	0,10	3,6	6,0	64
582.0200.020	2,0	0,20	4,0	6,0	64
582.0250.020	2,5	0,20	5,0	6,0	64
582.0300.020	3,0	0,20	6,0	6,0	64
582.0300.030	3,0	0,30	6,0	6,0	64
582.0400.020	4,0	0,20	6,0	6,0	64
582.0400.040	4,0	0,40	6,0	6,0	64
582.0500.020	5,0	0,20	8,0	6,0	64
582.0600.020	6,0	0,20	8,0	6,0	64
582.0600.060	6,0	0,60	8,0	6,0	64

VHM-Torusfräser für die HSC-Bearbeitung im Formenbau

- Kurze Ausführung
- HM-Sorte: EZ 44
- Hochpräziser Zylinderschaft
- Feinstgeschliffene Schneiden
- Auch gut geeignet zur Bearbeitung von Edelstahl, Guss, Kunststoffe
- Bis 45 HRC zum Schruppen geeignet

Solid carbide end mill with corner radius for HSC milling in mould making

- Short design
- Carbide grade: EZ 44
- Highly precise cylindrical shaft
- Finest ground flutes
- Also well suited for the processing of stainless steel, cast iron, plastics
- Up to 45 HRC suitable for roughing

Fraise toriques en carbure monobloc pour l'usinage HSC dans la fabrication de moules

- Modèle court
- Sorte de métal dur: EZ 44
- Queue cylindrique de haute précision
- Dents à poli très fin
- Convient aussi bien pour l'usinage, de l'acier inox, de la fonte, des plastiques
- Convient pour dégrossir jusqu'à 45 HRC

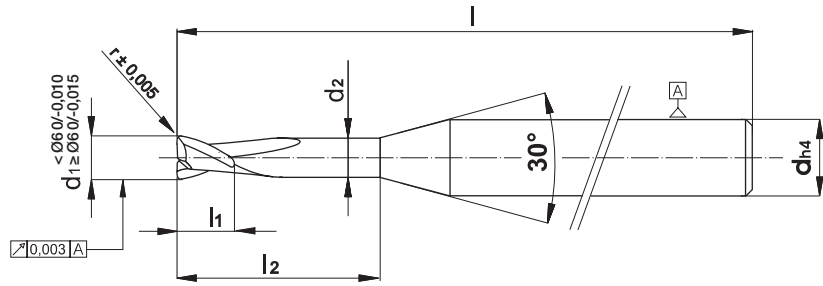

VHM-Torusfräser für die HSC-Bearbeitung im Formenbau

- Mit Freilänge
- HM-Sorte: EZ 44
- Hochpräziser Zylinderschaft
- Feinstgeschliffene Schneiden
- Auch gut geeignet zur Bearbeitung von Edelstahl, Guss, Kunststoffe
- Bis 45 HRC zum Schruppen geeignet

Solid carbide end mill with corner radius for HSC milling in mould making

- With free length
- Carbide grade: EZ 44
- Highly precise cylinder shaft
- Finest ground flutes
- Also well suited for the processing of stainless steel, cast iron, plastics
- Up to 45 HRC suitable for roughing

Fraise toriques en carbure monobloc pour l'usinage HSC dans la fabrication de moules

- Avec longueur libre
- Sorte de métal dur: EZ 44
- Queue cylindrique de haute précision
- Dents à poli très fin
- Convient aussi bien pour l'usinage de l'acier inox, de la fonte, des plastiques
- Convient pour dégrossir jusqu'à 45 HRC

Bestell-Nr. order no N° référence	d ₁	d ₂	r	l ₁	l ₂	d	l
583.0030.0250.005	0,3	0,27	0,05	0,6	2,5	6,0	64
583.0050.0250.005	0,5	0,45	0,05	1,0	2,5	6,0	64
583.0050.0500.005					5,0		
583.0060.0300.005	0,6	0,55	0,05	1,2	3,0	6,0	64
583.0060.0600.005					6,0		
583.0080.0400.005	0,8	0,75	0,05	1,6	4,0	6,0	64
583.0080.0800.005					8,0		
583.0100.0500.010					5,0		
583.0100.1000.010	1,0	0,95	0,10	2,0	10,0	6,0	64
583.0100.1500.010					15,0		
583.0120.0600.010	1,2	1,15	0,10	2,4	6,0	6,0	64
583.0120.1200.010					12,0		
583.0140.0700.010	1,4	1,35	0,10	2,8	7,0	6,0	64
583.0140.1400.010					14,0		
583.0150.0750.010	1,5	1,45	0,10	3,0	7,5	6,0	64
583.0150.1500.010					15,0		
583.0160.0800.010	1,6	1,55	0,10	3,2	8,0	6,0	64
583.0160.1600.010					16,0		
583.0180.0900.010	1,8	1,75	0,10	3,6	9,0	6,0	64
583.0180.1800.010					18,0		
583.0200.1000.020	2,0	1,92	0,20	4,0	10,0	6,0	64
583.0200.2000.020					20,0		
583.0250.1250.020	2,5	2,42	0,20	5,0	12,5	6,0	64
583.0250.2000.020					20,0		
583.0300.1500.030			0,30		15,0		
583.0300.1500.020	3,0	2,90	0,20	6,0	15,0	6,0	64
583.0300.2500.020			0,20		25,0		
583.0400.1500.040	4,0	3,90	0,40	6,0	15,0	6,0	64
583.0400.1500.020			0,20				
583.0500.1800.020	5,0	4,90	0,20	8,0	18,0	6,0	64
583.0600.1800.020	6,0	5,90	0,20	8,0	18,0	6,0	64
583.0600.1800.060			0,60				



583H

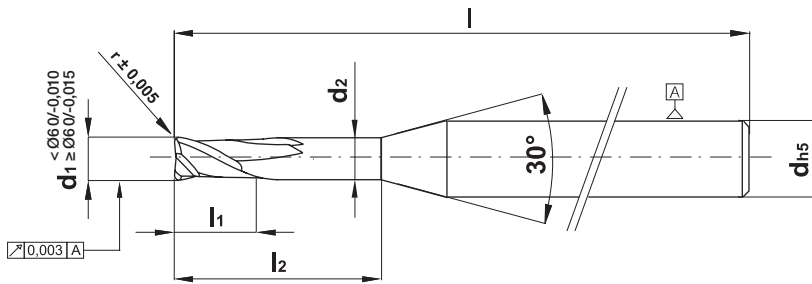

Bestell-Nr. order no N° référence	d ₁	d ₂	r	l ₁	l ₂	d	l
583H020.005.007	0,2	0,20	0,05	0,7	0,7	4,0	53
583H020.005.010		0,18			1,0		
583H020.005.015		0,18			1,5		
583H020.005.020		0,18			2,0		
583H030.005.010	0,3	0,27	0,05	0,7	1,0	4,0	53
583H030.005.020					2,0		
583H030.005.030					3,0		
583H030.005.040					4,0		
583H030.005.050					5,0		
583H040.005.012	0,4	0,35	0,05	0,7	1,2	4,0	53
583H040.005.020					2,0		
583H040.005.030					3,0		
583H040.005.040					4,0		
583H040.005.050					5,0		
583H040.005.060					6,0		
583H040.005.070					7,0		
583H050.005.013	0,5	0,45	0,05	0,7	1,3	4,0	53
583H050.005.025					2,5		
583H050.005.035					3,5		
583H050.005.045					4,5		
583H050.005.065					6,5		
583H050.005.085					8,5		
583H050.005.100					10,0		
583H060.005.015	0,6	0,55	0,05	0,7	1,5	4,0	53
583H060.005.030					3,0		
583H060.005.050					5,0		
583H060.005.060					6,0		
583H060.005.080					8,0		
583H060.005.090					9,0		
583H060.005.100					10,0		
583H080.008.020	0,8	0,75	0,08	1,0	2,0	4,0	53
583H080.008.050					5,0		
583H080.008.080					8,0		
583H080.008.100					10,0		
583H080.008.120					12,0		
583H080.008.140					14,0		
583H080.008.160					16,0		

VHM-Torusfräser für die HSC-Bearbeitung im Formenbau

- Mit Freilänge
- HM-Sorte: EZ 22
- Feinstgeschliffene Schneiden
- Stabile Schneidkante
- Auch gut geeignet zur Bearbeitung von Ni-Cr-Legierungen
- Cobalt-Chrom

Solid carbide end mill with corner radius for HSC milling in mould making

- With free length
- Carbide grade: EZ 22
- Finest ground flutes
- Robust flute
- Also well suited for the processing of Ni-Cr alloys
- Cobalt-Chrome

Fraise toriques en carbure monobloc pour l'usinage HSC dans la fabrication de moules

- Avec longueur libre
- Sorte de métal dur: EZ 22
- Dents à poli très fin
- Taillant résistant
- Convient aussi bien pour l'usinage des alliages NiCr
- Cobalt-Chrome

Siehe auch Folgeseite
See also next page
Voir aussi page suivante

583H

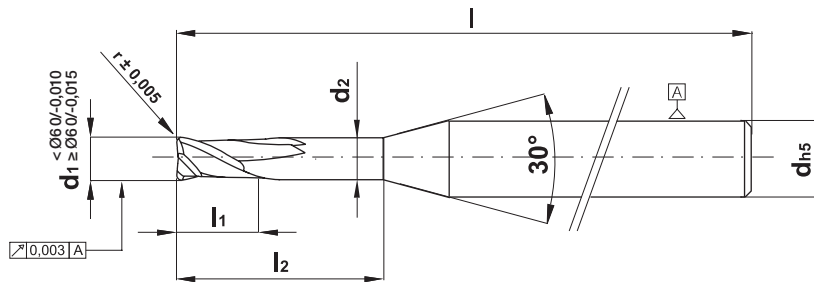
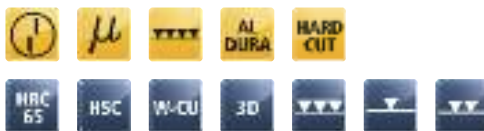

VHM-Torusfräser für die HSC-Bearbeitung im Formenbau

- Mit Freilänge
- HM-Sorte: EZ 22
- Feinstgeschliffene Schneiden
- Stabile Schneidkante
- Auch gut geeignet zur Bearbeitung von Ni-Cr-Legierungen
- Cobalt-Chrom

Solid carbide end mill with corner radius for HSC milling in mould making

- With free length
- Carbide grade: EZ 22
- Finest ground flutes
- Robust flute
- Also well suited for the processing of Ni-Cr alloys
- Cobalt-Chrome

Fraise toriques en carbure monobloc pour l'usinage HSC dans la fabrication de moules

- Avec longueur libre
- Sorte de métal dur: EZ 22
- Dents à poli très fin
- Taillant résistant
- Convient aussi bien pour l'usinage des alliages NiCr
- Cobalt-Chrome

Bestell-Nr. order no N° référence	d ₁	d ₂	r	l ₁	l ₂	d	l
583H100.010.025			0,10		2,5		
583H100.010.030			0,10		3		
583H100.010.040			0,10		4,0		
583H100.010.050			0,10		5		
583H100.010.060			0,10		6,0		
583H100.010.070			0,10		7		
583H100.010.080			0,10		8,0		
583H100.010.090			0,10		9		
583H100.010.100			0,10		10		
583H100.010.110			0,10		11		
583H100.010.120			0,10		12,0		
583H100.010.140			0,10		14		
583H100.010.160			0,10		16,0		
583H100.010.200			0,10		20,0		
583H100.010.250	1,0	0,95	0,10	1,5	25	4,0	53
583H100.020.025			0,20		2,5		
583H100.020.030			0,20		3		
583H100.020.040			0,20		4		
583H100.020.050			0,20		5		
583H100.020.060			0,20		6,0		
583H100.020.070			0,20		7		
583H100.020.080			0,20		8		
583H100.020.090			0,20		9		
583H100.020.100			0,20		10		
583H100.020.110			0,20		11		
583H100.020.120			0,20		12,0		
583H100.020.140			0,20		14		
583H100.020.160			0,20		16		
583H100.020.200			0,20		20,0		
583H100.020.250			0,20		25		
583H120.010.030					3,0		
583H120.010.050					5,0		
583H120.010.080					8,0		
583H120.010.110	1,2	1,15	0,10	1,5	11,0	4,0	53
583H120.010.130					13,0		
583H120.010.160					16,0		
583H120.010.180					18,0		
583H140.010.035					3,5		
583H140.010.060					6,0		
583H140.010.100					10,0		
583H140.010.120	1,4	1,35	0,10	1,5	12,0	4,0	53
583H140.010.150					15,0		
583H140.010.180					18,0		



583H

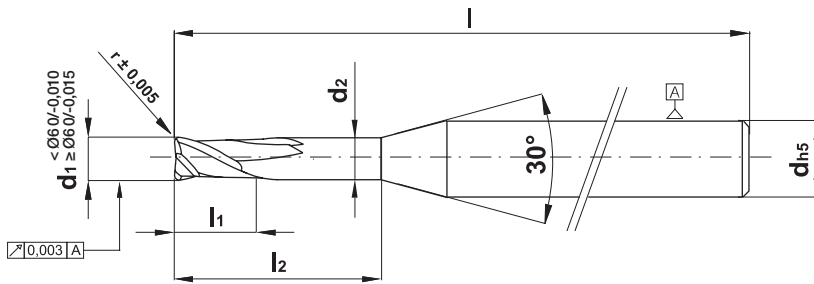

Bestell-Nr. order no N° référence	d ₁	d ₂	r	l ₁	l ₂	d	l					
583H150.015.040	1,5	1,45	0,15	1,5	4,0	4,0	62					
583H150.015.060			0,15		6,0							
583H150.015.080			0,15		8,0							
583H150.015.100			0,15		10,0							
583H150.015.120			0,15		12,0							
583H150.015.150			0,15		15,0							
583H150.015.200			0,15		20,0							
583H150.015.250			0,15		25,0							
583H150.030.040			1,6		1,54			0,30	1,5	4,0	4,0	62
583H150.030.060								0,30		6,0		
583H150.030.100	0,30	10,0										
583H150.030.150	0,30	15,0										
583H160.020.050	1,8	1,74		0,20		1,5	5,0	4,0		62		
583H160.020.080			8,0									
583H160.020.120			12,0									
583H160.020.160			16,0									
583H160.020.200	20,0	2,0	1,95	2,5	4,0	62						
583H180.020.060	6,0											
583H180.020.090	9,0											
583H180.020.130	13,0											
583H180.020.180	18,0											
583H180.020.220	22,0											
583H200.020.030	3,0											
583H200.020.040	4,0											
583H200.020.060	6,0											
583H200.020.080	8,0											
583H200.020.100	10,0											
583H200.020.120	12,0											
583H200.020.140	14,0											
583H200.020.160	16,0											
583H200.020.180	18,0											
583H200.020.200	20,0											
583H200.020.220	22,0											
583H200.020.240	24,0											
583H200.020.250	25,0											
583H200.050.030	3,0											
583H200.050.040	4,0											
583H200.050.060	6,0											
583H200.050.080	8,0											
583H200.050.100	10,0											
583H200.050.120	12,0											
583H200.050.140	14,0											
583H200.050.160	16,0											
583H200.050.180	18,0											
583H200.050.200	20,0											
583H200.050.220	22,0											
583H200.050.240	24,0											
583H200.050.250	25,0											

VHM-Torusfräser für die HSC-Bearbeitung im Formenbau

- Mit Freilänge
- HM-Sorte: EZ 22
- Feinstgeschliffene Schneiden
- Stabile Schneidkante
- Auch gut geeignet zur Bearbeitung von Ni-Cr-Legierungen
- Cobalt-Chrom

Solid carbide end mill with corner radius for HSC milling in mould making

- With free length
- Carbide grade: EZ 22
- Finest ground flutes
- Robust flute
- Also well suited for the processing of Ni-Cr alloys
- Cobalt-Chrome

Fraise toriques en carbure monobloc pour l'usinage HSC dans la fabrication de moules

- Avec longueur libre
- Sorte de métal dur: EZ 22
- Dents à poli très fin
- Taillant résistant
- Convient aussi bien pour l'usinage des alliages NiCr
- Cobalt-Chrome

Siehe auch Folgeseite
See also next page
Voir aussi page suivante

583H

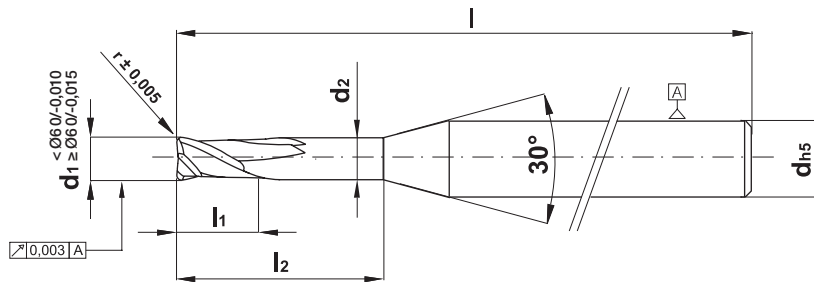
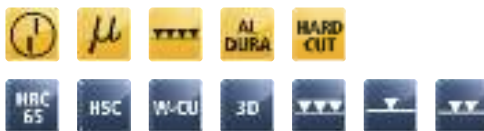

VHM-Torusfräser für die HSC-Bearbeitung im Formenbau

- Mit Freilänge
- HM-Sorte: EZ 22
- Feinstgeschliffene Schneiden
- Stabile Schneidkante
- Auch gut geeignet zur Bearbeitung von Ni-Cr-Legierungen
- Cobalt-Chrom

Solid carbide end mill with corner radius for HSC milling in mould making

- With free length
- Carbide grade: EZ 22
- Finest ground flutes
- Robust flute
- Also well suited for the processing of Ni-Cr alloys
- Cobalt-Chrome

Fraise toriques en carbure monobloc pour l'usinage HSC dans la fabrication de moules

- Avec longueur libre
- Sorte de métal dur: EZ 22
- Dents à poli très fin
- Taillant résistant
- Convient aussi bien pour l'usinage des alliages NiCr
- Cobalt-Chrome

Bestell-Nr. order no N° référence	d ₁	d ₂	r	l ₁	l ₂	d	l
583H250.025.080	2,5	2,42	0,25	2,5	8,0	4,0	62
583H250.025.120					12,0		
583H250.025.160					16,0		
583H250.025.200					20,0		
583H250.025.220					22,0		
583H250.025.250	25,0						
583H300.030.045	3,0	2,90	0,30	3,5	4,5	6,0	62
583H300.030.060			0,30		6,0		62
583H300.030.080			0,30		8,0		62
583H300.030.090			0,30		9,0		62
583H300.030.120			0,30		12,0		62
583H300.030.150			0,30		15,0		62
583H300.030.160			0,30		16,0		62
583H300.030.180			0,30		18,0		62
583H300.030.200			0,30		20,0		62
583H300.030.210			0,30		21,0		62
583H300.030.240			0,30		24,0		62
583H300.030.250			0,30		25,0		62
583H300.030.270			0,30		27,0		62
583H300.030.300			0,30		30,0		62
583H300.030.330			0,30		33,0		75
583H300.030.360	0,30	36,0	75				
583H300.050.045	3,0	2,90	0,50	3,5	4,5	6,0	62
583H300.050.060			0,50		6,0		62
583H300.050.080			0,50		8,0		62
583H300.050.090			0,50		9,0		62
583H300.050.120			0,50		12,0		62
583H300.050.150			0,50		15,0		62
583H300.050.160			0,50		16,0		62
583H300.050.180			0,50		18,0		62
583H300.050.200			0,50		20,0		62
583H300.050.210			0,50		21,0		62
583H300.050.240			0,50		24,0		62
583H300.050.250			0,50		25,0		62
583H300.050.270			0,50		27,0		62
583H300.050.300			0,50		30,0		62
583H300.050.330			0,50		33,0		75
583H300.050.360	0,50	36,0	75				
583H400.040.100	4,0	3,90	0,40	4,5	10,0	6,0	62
583H400.040.150			0,40		15,0		62
583H400.040.200			0,40		20,0		62
583H400.040.250			0,40		25,0		62
583H400.040.300			0,40		30,0		62
583H400.040.350			0,40		35,0		75
583H400.050.100			0,50		10,0		62
583H400.050.200			0,50		20,0		62
583H400.050.300			0,50		30,0		62



583H

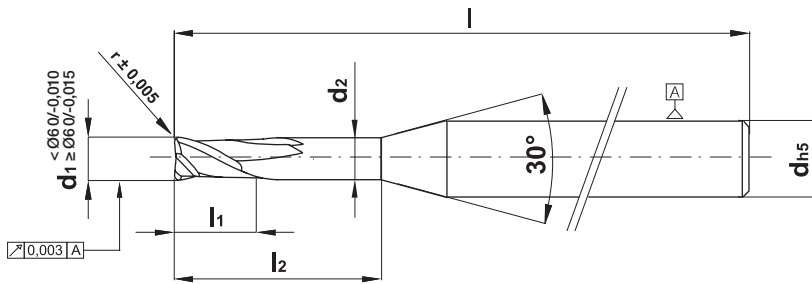

Bestell-Nr. order no N° référence	d ₁	d ₂	r	l ₁	l ₂	d	l
583H500.050.100					10,0		62
583H500.050.125					12,5		62
583H500.050.150					15,0		62
583H500.050.200	5,0	4,90	0,50	5,5	20,0	6,0	62
583H500.050.250					25,0		62
583H500.050.300					30,0		62
583H500.050.350					35,0		75
583H600.060.100					10,0		62
583H600.060.150					15,0		62
583H600.060.200					20,0		62
583H600.060.250	6,0	5,90	0,60	6,5	25,0	6,0	62
583H600.060.300					30,0		62
583H600.060.350					35,0		75
583H600.060.400					40,0		75
583H800.050.240	8,0	7,90	0,50	8,5	24,0	8,0	75
583H800.050.400					40,0		75

VHM-Torusfräser für die HSC-Bearbeitung im Formenbau

- Mit Freilänge
- HM-Sorte: EZ 22
- Feinstgeschliffene Schneiden
- Stabile Schneidkante
- Auch gut geeignet zur Bearbeitung von Ni-Cr-Legierungen
- Cobalt-Chrom

Solid carbide end mill with corner radius for HSC milling in mould making

- With free length
- Carbide grade: EZ 22
- Finest ground flutes
- Robust flute
- Also well suited for the processing of Ni-Cr alloys
- Cobalt-Chrome

Fraise toriques en carbure monobloc pour l'usinage HSC dans la fabrication de moules

- Avec longueur libre
- Sorte de métal dur: EZ 22
- Dents à poli très fin
- Taillant résistant
- Convient aussi bien pour l'usinage des alliages NiCr
- Cobalt-Chrome

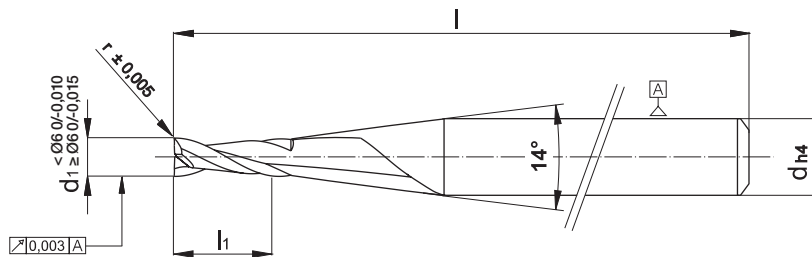
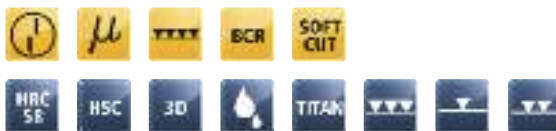

VHM-Torusfräser für die HSC-Bearbeitung im Formenbau

- Kurze Ausführung
- HM-Sorte: EZ 44
- Hochpräziser Zylinderschaft
- Feinstgeschliffene Schneiden
- Auch gut geeignet zur Bearbeitung von Edelstahl, Guss, Kunststoffe
- Bis 45 HRC zum Schruppen geeignet

Solid carbide end mill with corner radius for HSC milling in mould making

- Short design
- Carbide grade: EZ 44
- Highly precise cylindrical shaft
- Finest ground flutes
- Also well suited for the processing of stainless steel, cast iron, plastics
- Up to 45 HRC suitable for roughing

Fraise toriques en carbure monobloc pour l'usinage HSC dans la fabrication de moules

- Modèle court
- Sorte de métal dur: EZ 44
- Queue cylindrique de haute précision
- Dents à poli très fin
- Convient aussi pour l'usinage de l'acier inox, de la fonte, des plastiques
- Convient pour dégrossir jusqu'à 45 HRC

Bestell-Nr. order no N° référence	d ₁	r	l ₁	d	l
584.0100	1,0	0,25	2,0	6,0	64
584.0120	1,2	0,25	2,4	6,0	64
584.0140	1,4	0,25	2,8	6,0	64
584.0150	1,5	0,30	3,0	6,0	64
584.0160	1,6	0,30	3,2	6,0	64
584.0180	1,8	0,30	3,6	6,0	64
584.0200	2,0	0,50	4,0	6,0	64
584.0250	2,5	0,50	5,0	6,0	64
584.0300	3,0	0,50	6,0	6,0	64
584.0400	4,0	0,50	6,0	6,0	64
584.0500	5,0	0,50	8,0	6,0	64
584.0600	6,0	0,50	8,0	6,0	64

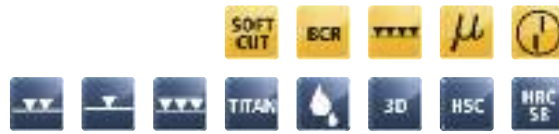

585

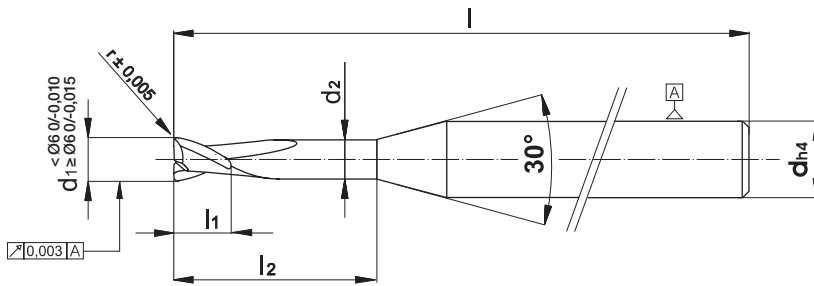

Bestell-Nr. order no N° référence	d ₁	d ₂	r	l ₁	l ₂	d	l
585.0100.0500	1,0	0,95	0,25	2,0	5,0	6,0	64
585.0120.0600	1,2	1,15	0,25	2,4	6,0	6,0	64
585.0140.0700	1,4	1,35	0,25	2,8	7,0	6,0	64
585.0150.0750	1,5	1,45	0,30	3,0	7,5	6,0	64
585.0160.0800	1,6	1,55	0,30	3,2	8,0	6,0	64
585.0180.0900	1,8	1,75	0,30	3,6	9,0	6,0	64
585.0200.1000	2,0	1,92	0,50	4,0	10,0	6,0	64
585.0250.1250	2,5	2,42	0,50	5,0	12,5	6,0	64
585.0300.1500	3,0	2,90	0,50	6,0	15,0	6,0	64
585.0400.1500	4,0	3,90	0,50	6,0	15,0	6,0	64
585.0500.1800	5,0	4,90	0,50	8,0	18,0	6,0	64
585.0600.1800	6,0	5,90	0,50	8,0	18,0	6,0	64

VHM-Torusfräser für die HSC-Bearbeitung im Formenbau

- Mit Freilänge
- HM-Sorte: EZ 44
- Hochpräziser Zylinderschaft
- Feinstgeschliffene Schneiden
- Auch gut geeignet zur Bearbeitung von Edelstahl, Guss, Kunststoffe
- Bis 45 HRC zum Schruppen geeignet

Solid carbide end mill with corner radius for HSC milling in mould making

- With free length
- Carbide grade: EZ 44
- Highly precise cylinder shaft
- Finest ground flutes
- Also well suited for the processing of stainless steel, cast iron, plastics
- Up to 45 HRC suitable for roughing

Fraise toriques en carbure monobloc pour l'usinage HSC dans la fabrication de moules

- Avec longueur libre
- Sorte de métal dur: EZ 44
- Queue cylindrique de haute précision
- Dents à poli très fin
- Convient aussi pour l'usinage de l'acier inox, de la fonte, des plastiques
- Convient pour dégrossir jusqu'à 45 HRC

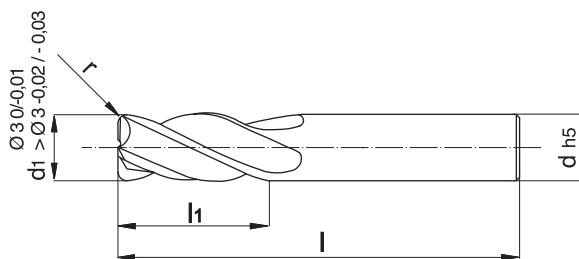
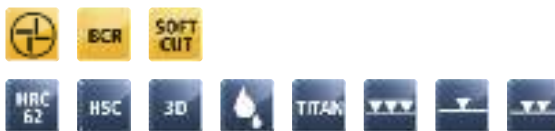

VHM-Torusfräser für die HSC-Bearbeitung im Formenbau

- Kurze Ausführung
- HM-Sorte: EZ 44
- Optimierte Beschichtung
- Eine Schneide zum Zentrum
- Auch gut geeignet zur Bearbeitung von Edelstahl, Guss, Kunststoffe, Titan
- Bis 58 HRC zum Schruppen geeignet

Solid carbide end mill with corner radius for HSC milling in mould making

- Short design
- Carbide grade: EZ 44
- Optimised coating
- One flute to the centre
- Also well suited for the processing of stainless steel, cast iron, plastics, titanium
- Up to 58 HRC suitable for roughing

Fraise toriques en carbure monobloc pour l'usinage HSC dans la fabrication de moules

- Modèle court
- Sorte de métal dur: EZ 44
- Revêtement optimisé
- Une dent à coupe au centre
- Convient aussi pour l'usinage de l'acier inox, de la fonte, des plastiques, du titane
- Convient pour dégrossir jusqu'à 58 HRC

Bestell-Nr. order no N° référence	d ₁	r	l ₁	d	l
586.030.03	3,0	0,3	6,0	4,0	50
586.030.05		0,5			
586.040.03	4,0	0,3	8,0	4,0	50
586.040.05		0,5			60
586.040.10		1,0			60
586.040.15		1,5			60
586.050.03		0,3			10,0
586.050.05	0,5				
586.050.10	1,0				
586.050.15	1,5				
586.050.20	2,0				
586.060.03	6,0	0,3	12,0	6,0	70
586.060.05		0,5			
586.060.10		1,0			
586.060.15		1,5			
586.060.20		2,0			
586.060.25		2,5			
586.080.03	8,0	0,3	16,0	8,0	70
586.080.05		0,5			
586.080.10		1,0			
586.080.15		1,5			
586.080.20		2,0			
586.080.25		2,5			
586.080.30		3,0			
586.100.03	10,0	0,3	20,0	10,0	70
586.100.05		0,5			
586.100.10		1,0			
586.100.15		1,5			
586.100.20		2,0			
586.100.25		2,5			
586.100.30		3,0			
586.120.03		12,0			
586.120.05	0,5				
586.120.10	1,0				
586.120.15	1,5				
586.120.20	2,0				
586.120.25	2,5				
586.120.30	3,0				



586

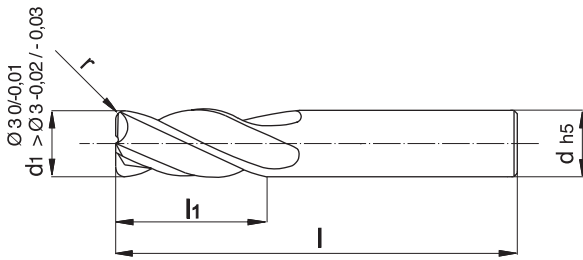

Bestell-Nr. order no N° référence	d ₁	r	l ₁	d	l
586.140.05	14,0	0,5	28,0	14,0	90
586.140.10		1,0			
586.140.15		1,5			
586.140.20		2,0			
586.140.25		2,5			
586.140.30	3,0				
586.160.10	16,0	1,0	32,0	16,0	90
586.160.20		2,0			
586.160.30		3,0			
586.200.10	20,0	1,0	40,0	20,0	120
586.200.20		2,0			
586.200.30		3,0			

VHM-Torusfräser für die HSC-Bearbeitung im Formenbau

- ☑ Kurze Ausführung
- ☑ HM-Sorte: EZ 44
- ☑ Optimierte Beschichtung
- ☑ Eine Schneide zum Zentrum
- ☑ Auch gut geeignet zur Bearbeitung von Edelstahl, Guss, Kunststoffe, Titan
- ☑ Bis 58 HRC zum Schruppen geeignet

Solid carbide end mill with corner radius for HSC milling in mould making

- ☑ Short design
- ☑ Carbide grade: EZ 44
- ☑ Optimised coating
- ☑ One flute to the centre
- ☑ Also well suited for the processing of stainless steel, cast iron, plastics, titanium
- ☑ Up to 58 HRC suitable for roughing

Fraise toriques en carbure monobloc pour l'usinage HSC dans la fabrication de moules

- ☑ Modèle court
- ☑ Sorte de métal dur: EZ 44
- ☑ Revêtement optimisé
- ☑ Une dent à coupe au centre
- ☑ Convient aussi pour l'usinage de l'acier inox, de la fonte, des plastiques, du titane
- ☑ Convient pour dégrossir jusqu'à 58 HRC

587

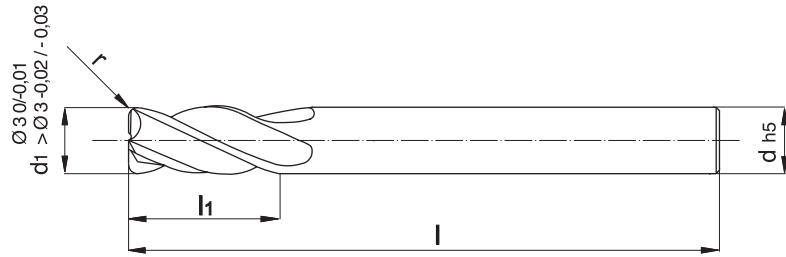

VHM-Torusfräser für die HSC-Bearbeitung im Formenbau

- Lange Ausführung
- HM-Sorte: EZ 44
- Optimierte Beschichtung
- Eine Schneide zum Zentrum
- Auch gut geeignet zur Bearbeitung von Edelstahl, Guss, Kunststoffe, Titan
- Bis 58 HRC zum Schruppen geeignet

Solid carbide end mill with corner radius for HSC milling in mould making

- Long design
- Carbide grade: EZ 44
- Optimised coating
- One flute to the centre
- Also well suited for the processing of stainless steel, cast iron, plastics, titanium
- Up to 58 HRC suitable for roughing

Fraise toriques en carbure monobloc pour l'usinage HSC dans la fabrication de moules

- Modèle long
- Sorte de métal dur: EZ 44
- Revêtement optimisé
- Une dent à coupe au centre
- Convient aussi pour l'usinage de l'acier inox, de la fonte, des plastiques, du titane
- Convient pour dégrossir jusqu'à 58 HRC

Bestell-Nr. order no N° référence	d ₁	r	l ₁	d	l
587.030.03	3,0	0,3	6,0	3,0	70
587.030.05		0,5			
587.040.03	4,0	0,3	8,0	4,0	80
587.040.05		0,5			
587.040.10		1,0			
587.040.15		1,5			
587.050.03	5,0	0,3	10,0	5,0	100
587.050.05		0,5			
587.050.10		1,0			
587.050.15		1,5			
587.050.20		2,0			
587.060.03	6,0	0,3	12,0	6,0	100
587.060.05		0,5			
587.060.10		1,0			
587.060.15		1,5			
587.060.20		2,0			
587.060.25	2,5				
587.080.03	8,0	0,3	16,0	8,0	100
587.080.05		0,5			
587.080.10		1,0			
587.080.15		1,5			
587.080.20		2,0			
587.080.25		2,5			
587.080.30	3,0				
587.100.03	10,0	0,3	20,0	10,0	120
587.100.05		0,5			
587.100.10		1,0			
587.100.15		1,5			
587.100.20		2,0			
587.100.25		2,5			
587.100.30	3,0				
587.120.03	12,0	0,3	24,0	12,0	120
587.120.05		0,5			
587.120.10		1,0			
587.120.15		1,5			
587.120.20		2,0			
587.120.25		2,5			
587.120.30		3,0			



587

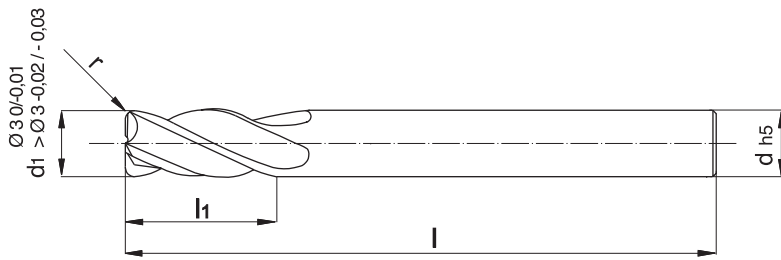

Bestell-Nr. order no N° référence	d ₁	r	l ₁	d	l
587.140.05	14,0	0,5	28,0	14,0	120
587.140.10		1,0			
587.140.15		1,5			
587.140.20		2,0			
587.140.25		2,5			
587.140.30	3,0				
587.160.10	16,0	1,0	32,0	16,0	120
587.160.20		2,0			
587.160.30		3,0			
587.200.10	20,0	1,0	40,0	20,0	160
587.200.20		2,0			
587.200.30		3,0			

VHM-Torusfräser für die HSC-Bearbeitung im Formenbau

- ☑ Lange Ausführung
- ☑ HM-Sorte: EZ 44
- ☑ Optimierte Beschichtung
- ☑ Eine Schneide zum Zentrum
- ☑ Auch gut geeignet zur Bearbeitung von Edelstahl, Guss, Kunststoffe, Titan
- ☑ Bis 58 HRC zum Schruppen geeignet

Solid carbide end mill with corner radius for HSC milling in mould making

- ☑ Long design
- ☑ Carbide grade: EZ 44
- ☑ Optimised coating
- ☑ One flute to the centre
- ☑ Also well suited for the processing of stainless steel, cast iron, plastics, titanium
- ☑ Up to 58 HRC suitable for roughing

Fraise toriques en carbure monobloc pour l'usinage HSC dans la fabrication de moules

- ☑ Modèle long
- ☑ Sorte de métal dur: EZ 44
- ☑ Revêtement optimisé
- ☑ Une dent à coupe au centre
- ☑ Convient aussi pour l'usinage de l'acier inox, de la fonte, des plastiques, du titane
- ☑ Convient pour dégrossir jusqu'à 58 HRC

594

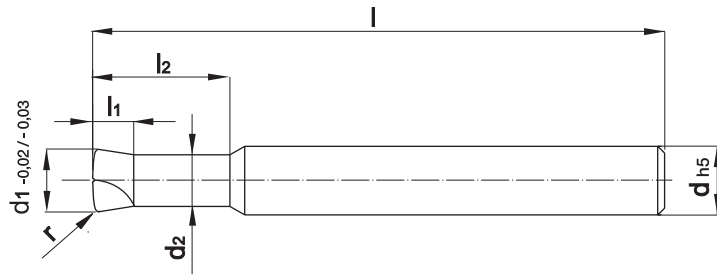

VHM-Highfeedfräser für die HSC-Bearbeitung im Formenbau

- Mit Freilänge
- Kurze und lange Ausführung
- HM-Sorte: EZ 44
- Schneidengeometrie mit großer axialer Ableitung der Schnittkräfte, dadurch hohe Laufruhe
- Einfahrampenwinkel 1°, bitte ER Programmierung beachten

Solide carbide high feed mill for HSC milling in mould making

- With free length
- Short and long design
- Carbide grade: EZ 44
- Flute geometry with high axial channelling of the cutting forces and thus very quiet running
- Entry ramp angle 1°, please observe CR programming

Fraise High Feed en carbure monobloc pour l'usinage HSC dans la fabrication de moules

- Avec longueur libre
- Modèles court et long
- Sorte de métal dur: EZ 44
- Géométrie de dents avec grand déport axial des forces de coupe pour un travail sans vibrations
- Angle de la rampe d'attaque de 1°
Respectez la programmation pour rayon de coins

Bestell-Nr. order no N° référence	d ₁	d ₂	r	l ₁	l ₂	d	l
594.0600.300	6,0	5,0	0,4	2,5	30,0	6,0	70
594.0800.300	8,0	7,0	0,6	3,0	30,0	8,0	70
594.1000.300	10,0	9,0	0,7	3,0	30,0	10,0	70
594.1200.300	12,0	11,0	0,9	4,5	30,0	12,0	74
594.1600.300	16,0	15,0	1,0	5,5	30,0	16,0	90
594.0600.420	6,0	5,0	0,4	2,5	42,0	6,0	90
594.0800.420	8,0	7,0	0,6	3,0	42,0	8,0	90
594.1000.420	10,0	9,0	0,7	3,0	42,0	10,0	90
594.1200.420	12,0	11,0	0,9	4,5	42,0	12,0	90
594.1600.700	16,0	15,0	1,0	5,5	70,0	16,0	110
594.2000.900	20,0	19,0	1,0	8,5	90,0	20,0	135

Eckenradiusprogrammierung : Corner radius programming: Programmation du rayon d'arrondi:			
ø 6,0	0,4	=>	0,75
ø 8,0	0,6	=>	1,10
ø 10,0	0,7	=>	1,30
ø 12,0	0,9	=>	1,40
ø 16,0	1,0	=>	1,60
ø 20,0	1,0	=>	2,00



594H

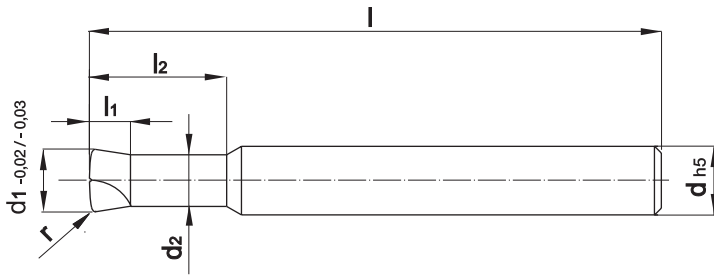

Bestell-Nr. order no N° référence	d ₁	d ₂	r	l ₁	l ₂	d	l
594H0600.300	6,0	5,0	0,4	2,5	30,0	6,0	70
594H0800.300	8,0	7,0	0,6	3,0	30,0	8,0	70
594H1000.300	10,0	9,0	0,7	3,0	30,0	10,0	70
594H1200.300	12,0	11,0	0,9	4,5	30,0	12,0	74
594H1600.300	16,0	15,0	1,0	5,5	30,0	16,0	90
Eckenradiusprogrammierung : Corner radius programming: Programmation du rayon d'arrondi:							
	∅ 6,0		0,4	=>			0,75
	∅ 8,0		0,6	=>			1,10
	∅ 10,0		0,7	=>			1,30
	∅ 12,0		0,9	=>			1,40
	∅ 16,0		1,0	=>			1,60
	∅ 20,0		1,0	=>			2,00

VHM-Highfeedfräser für die HSC-Bearbeitung im Formenbau

- Mit Freilänge
- Kurze Ausführung
- HM-Sorte: EZ 22
- Schneidengeometrie mit großer axialer Ableitung der Schnittkräfte, dadurch hohe Laufruhe
- Einfahrrampenwinkel 1°, bitte ER Programmierung beachten

Solide carbide high feed mill for HSC milling in mould making

- With free length
- Short design
- Carbide grade: EZ 22
- Flute geometry with high axial channelling of the cutting forces and thus very quiet running
- Entry ramp angle 1°, please observe CR programing

Fraise High Feed en carbure monobloc pour l'usinage HSC dans la fabrication de moules

- Avec longueur libre
- Modèle court
- Sorte de métal dur: EZ 22
- Géométrie de dents avec grand déport axial des forces de coupe pour un travail sans vibrations
- Angle de la rampe d'attaque de 1°
Respectez la programmation pour rayon de coins

595

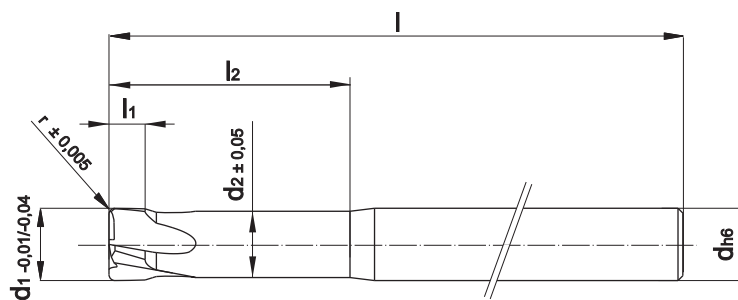
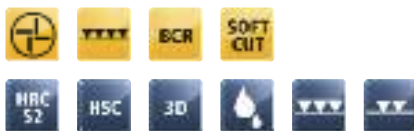

VHM-Torusfräser für die HSC-Bearbeitung im Formenbau

- Mit Freilänge
- HM-Sorte: EZ 44
- Zwei Schneiden zum Zentrum
- Zum Stech-/Tauchfräsen
- Schruppbearbeitung nur in Härten unter 40 HRC
- Auch gut geeignet zur Bearbeitung von Edelstahl

Solid carbide end mill with corner radius for HSC milling in mould making

- With free length
- Carbide grade: EZ 44
- Two flutes to the centre
- For plunge milling
- Roughing work only in hardnesses below 40 HRC
- Also well suited for the processing of stainless steel

Fraise toriques en carbure monobloc pour l'usinage HSC dans la fabrication de moules

- Avec longueur libre
- Sorte de métal dur: EZ 44
- Deux dents à coupe au centre
- Pour fraisage en plongée
- Dégrossissage seulement avec des duretés inférieures à 40 HRC
- Convient aussi pour l'usinage de l'inox

Bestell-Nr. order no N° référence	d ₁	d ₂	r	l ₁	l ₂	d	l
595.060.040.05	4,0	3,7	0,5	2,5	20,0	6,0	70
595.060.060.05	6,0	5,5	0,5	3,0	28,0	6,0	80
595.060.060.10			1,0				
595.080.080.05	8,0	7,4	0,5	3,5	35,0	8,0	105
595.080.080.10			1,0				
595.100.100.10	10,0	9,2	1,0	4,0	45,0	10,0	105
595.100.100.15			1,5				
595.120.120.10	12,0	11,0	1,0	4,0	50,0	12,0	105
595.120.120.15			1,5				



595H

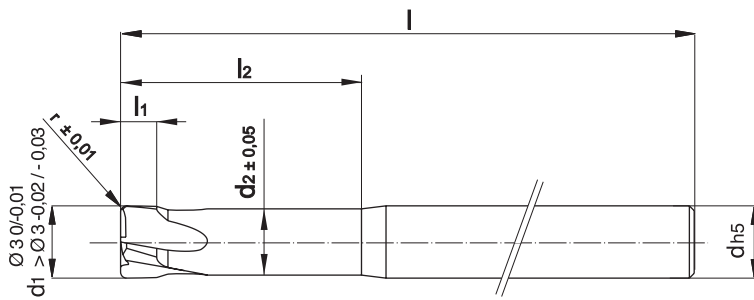

Bestell-Nr. order no N° référence	d ₁	d ₂	r	l ₁	l ₂	d	l
595H0100.010.040	1,0	0,95	0,10	0,9	4,0	4,0	50
595H0150.015.060	1,5	1,45	0,15	1,3	6,0	4,0	50
595H0200.020.080	2,0	1,90	0,20	1,6	8,0	4,0	50
595H0300.020.120	3,0	2,90	0,20	2,0	12,0	4,0	50
595H0300.050.120			0,50				
595H0400.020.150			0,20				
595H0400.050.150	4,0	3,80	0,50	2,5	15,0	6,0	60
595H0400.100.150			1,00				
595H0600.020.200			0,20				
595H0600.050.200	6,0	5,60	0,50	3,0	20,0	6,0	60
595H0600.100.200			1,00				
595H0600.150.200			1,50				
595H0800.050.300			0,50				
595H0800.100.300	8,0	7,60	1,00	3,5	30,0	8,0	75
595H0800.150.300			1,50				
595H0800.200.300			2,00				
595H1000.100.350			1,00				
595H1000.150.350	10,0	9,50	1,50	4,0	35,0	10,0	75
595H1000.200.350			2,00				
595H1200.100.400			1,00				
595H1200.150.400	12,0	11,50	1,50	4,0	40,0	12,0	85
595H1200.200.400			2,00				
595H1200.300.400			3,00				

VHM-Highfeed-Torusfräser für die HSC-Bearbeitung im Formenbau

- Mit Freilänge
- HM-Sorte: EZ 22
- Werkzeug mit großer Spankammer für hohe Vorschübe
- Definierter Eckenradius dadurch auch zur Bearbeitung von Restmaterial gut geeignet

Solid carbide end mill with corner radius for HSC milling in mould making

- With free length
- Carbide grade: EZ22
- Tool with high chipping spaces for high feed rates
- Defined corner radius this also makes it well suited for milling waste material

Fraise toriques High Feed en carbure monobloc pour l'usinage HSC dans la fabrication de moules

- Avec longueur libre
- Sorte de métal dur: EZ 22
- Outil avec grand espace entre dents pour grandes avances
- Rayon de coins défini convenant bien aussi pour l'usinage du matériau résiduel

597T

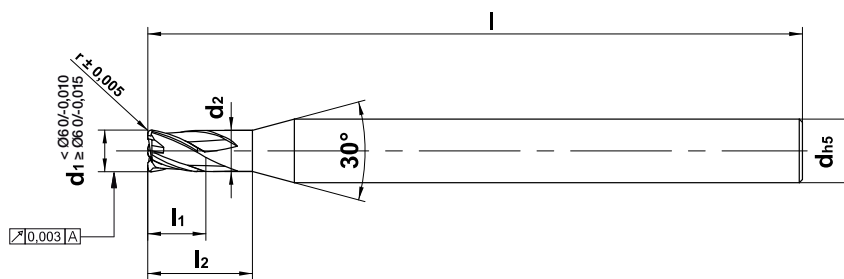
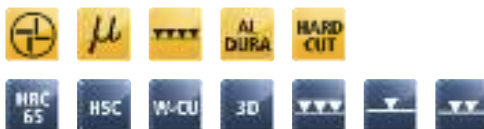

VHM-Torusfräser für die HSC-Bearbeitung im Formenbau

- Mit Freilänge
- HM-Sorte: EZ 22
- Ungleiche Zahnteilung und Drallsteigung
- Zwei Schneiden zum Zentrum

Solid carbide end mill with corner radius for HSC milling in mould making

- With free length
- Carbide grade: EZ 22
- Uneven pitch and uneven helix
- Two flutes to the centre

Fraise toriques en carbure monobloc pour l'usinage HSC dans la fabrication de moules

- Avec longueur libre
- Sorte de métal dur: EZ 22
- Configuration inégale des dents et pentes d'hélice
- Deux dents à coupe au centre

Bestell-Nr. order no N° référence	d ₁	d ₂	r	l ₁	l ₂	d	l
597.T4.200.005.060			0,05		6,0		
597.T4.200.005.150			0,05		15,0		
597.T4.200.020.060	2,0	1,95	0,20	2,5	6,0	4,0	55
597.T4.200.020.080			0,20		8,0		
597.T4.200.020.100			0,20		10,0		
597.T4.200.020.120			0,20		12,0		
597.T4.300.020.100			0,20		10,0		
597.T4.300.020.150			0,20		15,0		
597.T4.300.020.250			0,20		25,0		
597.T4.300.030.100	3,0	2,90	0,30	3,5	10,0	6,0	55
597.T4.300.050.100			0,50		10,0		
597.T4.300.050.150			0,50		15,0		
597.T4.300.050.250			0,50		25,0		
597.T4.400.005.100			0,05		10,0		
597.T4.400.020.100			0,20		10,0		
597.T4.400.020.150			0,20		15,0		
597.T4.400.020.200			0,20		20,0		
597.T4.400.020.300			0,20		30,0		
597.T4.400.040.100	4,0	3,90	0,40	4,5	10,0	6,0	55
597.T4.400.040.150			0,40		15,0		
597.T4.400.040.200			0,40		20,0		
597.T4.400.050.100			0,50		10,0		
597.T4.400.050.150			0,50		15,0		
597.T4.400.050.200			0,50		20,0		
597.T4.400.050.300			0,50		30,0		
597.T4.500.050.150	5,0	4,90	0,50	5,5	15,0	6,0	55
597.T4.600.005.150			0,05		15,0		50
597.T4.600.020.300			0,20		30,0		50
597.T4.600.030.150			0,30		15,0		50
597.T4.600.050.100			0,50		10,0		50
597.T4.600.050.150			0,50		15,0		50
597.T4.600.050.180			0,50		18,0		50
597.T4.600.050.300	6,0	5,90	0,50	6,5	30,0	6,0	50
597.T4.600.050.450			0,50		45,0		75
597.T4.600.100.150			1,00		15,0		50
597.T4.600.100.300			1,00		30,0		50
597.T4.600.100.450			1,00		45,0		75
597.T4.600.150.150			1,50		15,0		50
597.T4.600.150.300			1,50		30,0		50
597.T4.600.150.450			1,50		45,0		75



597T

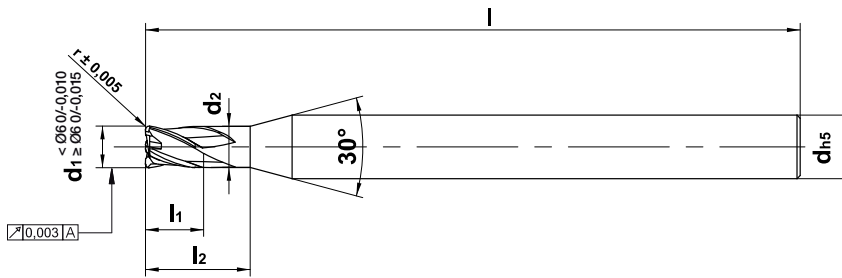

Bestell-Nr. order no N° référence	d ₁	d ₂	r	l ₁	l ₂	d	l
597.T4.800.020.400			0,20		40,0		
597.T4.800.030.300			0,30		30,0		
597.T4.800.050.300			0,50		30,0		
597.T4.800.050.450			0,50		45,0		
597.T4.800.050.600			0,50		60,0		
597.T4.800.080.300	8,0	7,90	0,80	8,5	30,0	8,0	85
597.T4.800.100.300			1,00		30,0		
597.T4.800.100.450			1,00		45,0		
597.T4.800.100.600			1,00		60,0		
597.T4.800.200.300			2,00		30,0		
597.T4.800.200.450			2,00		45,0		
597.T4.800.200.600			2,00		60,0		
597.T4.1000.020.450			0,20		45,0		80
597.T4.1000.020.600			0,20		60,0		100
597.T4.1000.050.300			0,50		30,0		80
597.T4.1000.050.450			0,50		45,0		80
597.T4.1000.050.600			0,50		60,0		100
597.T4.1000.100.300	10,0	9,90	1,00	10,5	30,0	10,0	80
597.T4.1000.100.450			1,00		45,0		80
597.T4.1000.100.600			1,00		60,0		100
597.T4.1000.200.300			2,00		30,0		80
597.T4.1000.200.450			2,00		45,0		80
597.T4.1000.200.600			2,00		60,0		100
597.T4.1200.020.600			0,20		60,0		90
597.T4.1200.050.300			0,50		30,0		90
597.T4.1200.050.600			0,50		60,0		90
597.T4.1200.050.900			0,50		90,0		130
597.T4.1200.100.300	12,0	11,90	1,00	10,5	30,0	12,0	90
597.T4.1200.100.600			1,00		60,0		90
597.T4.1200.100.900			1,00		90,0		130
597.T4.1200.200.300			2,00		30,0		90
597.T4.1200.200.600			2,00		60,0		90
597.T4.1200.200.900			2,00		90,0		130

VHM-Torusfräser für die HSC-Bearbeitung im Formenbau

- Mit Freilänge
- HM-Sorte: EZ 22
- Ungleiche Zahnteilung und Drallsteigung
- Zwei Schneiden zum Zentrum

Solid carbide end mill with corner radius for HSC milling in mould making

- With free length
- Carbide grade: EZ 22
- Uneven pitch and uneven helix
- Two flutes to the centre

Fraise toriques en carbure monobloc pour l'usinage HSC dans la fabrication de moules

- Avec longueur libre
- Sorte de métal dur: EZ 22
- Configuration inégale des dents et pentes d'hélice
- Deux dents à coupe au centre

598T

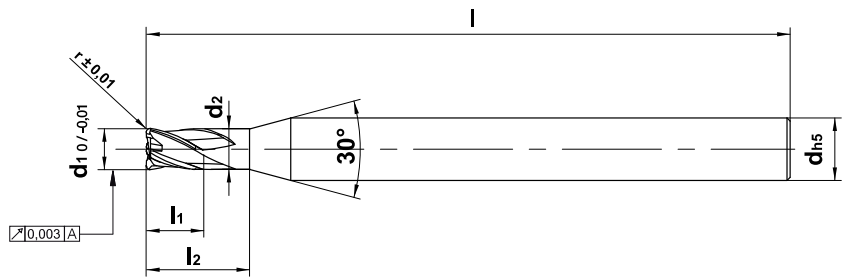

VHM-Torusfräser für die HSC-Bearbeitung im Formenbau

- HM-Sorte: EZ 22
- Ungleiche Zahnteilung
- Auch gut geeignet zur Bearbeitung von Edelstahl

Solid carbide end mill with corner radius for HSC milling in mould making

- Carbide grade: EZ 22
- Uneven pitch
- Also well suited for the processing of stainless steel

Fraise toriques en carbure monobloc pour l'usinage HSC dans la fabrication de moules

- Sorte de métal dur: EZ 22
- Configuration inégale des dents
- Convient aussi bien pour l'usinage de l'acier inox

Bestell-Nr. order no N° référence	d ₁	d ₂	r	l ₁	l ₂	d	l
598.T4.060.030.120			0,3				
598.T4.060.050.120	6,0	6,0	0,5	12,0	12,0	6,0	70
598.T4.060.100.120			1,0				
598.T4.080.030.160			0,3				
598.T4.080.050.160	8,0	8,0	0,5	16,0	16,0	8,0	80
598.T4.080.100.160			1,0				
598.T4.080.200.160			2,0				
598.T4.100.050.200			0,5				
598.T4.100.100.200	10,0	10,0	1,0	20,0	20,0	10,0	80
598.T4.100.150.200			1,5				
598.T4.100.200.200			2,0				
598.T4.120.050.240			0,5				
598.T4.120.100.240	12,0	12,0	1,0	24,0	24,0	12,0	90
598.T4.120.150.240			1,5				
598.T4.120.200.240			2,0				
598.T4.160.050.320			0,5				
598.T4.160.100.320	16,0	16,0	1,0	32,0	32,0	16,0	100
598.T4.160.150.320			1,5				
598.T4.160.200.320			2,0				



532

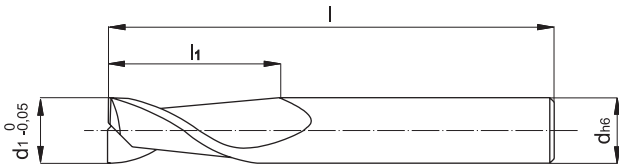

Bestell-Nr. order no N° référence	d ₁	l _i	d	l
532.010	1,0	4,0	3,0	38
532.015	1,5	4,5	3,0	38
532.020	2,0	6,3	3,0	38
532.025	2,5	9,5	3,0	38
532.030	3,0	12,0	3,0	38
532.035	3,5	12,0	4,0	50
532.040	4,0	14,0	4,0	50
532.045	4,5	16,0	6,0	50
532.050	5,0	16,0	6,0	50
532.060	6,0	19,0	6,0	50
532.070	7,0	19,0	8,0	63
532.080	8,0	20,0	8,0	63
532.090	9,0	22,0	10,0	75
532.100	10,0	22,0	10,0	75
532.110	11,0	25,0	12,0	75
532.120	12,0	25,0	12,0	75

VHM-Schaftfräser für die HSC-Bearbeitung im Formenbau

- HM-Sorte: EZ 21
- Zentrumschneidend mit 2 Schneiden
- Auch gut geeignet zur Bearbeitung von Stählen, Vergütungsstählen, Guss, Kupfer und Legierungen
- Bis 40 HRC zum Schruppen geeignet
- Auf Wunsch auch mit Beschichtung lieferbar

Solid carbide end mill for HSC milling in mould making

- Carbide grade: EZ 21
- Cutting to centre with 2 flutes
- Also well suited for the processing of steels, heat-treatable steels, cast iron, copper and alloys
- Up to 40 HRC suitable for roughing
- Can also be provided with coating if desired

Fraise à queue en carbure monobloc pour l'usinage HSC dans la fabrication de moules

- Sorte de métal dur: EZ 21
- Coupe au centre à deux dents
- Convient aussi bien pour l'usinage des aciers, aciers de traitement, fonte, cuivre et alliages
- Convient pour dégrossir jusqu'à 40 HRC
- Également avec revêtement sur demande

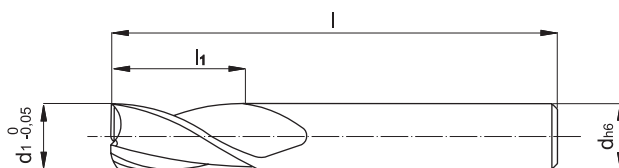

VHM-Schaftfräser für die HSC-Bearbeitung im Formenbau

- HM-Sorte: EZ 21
- Zentrumschneidend mit 3 Schneiden
- Auch gut geeignet zur Bearbeitung von Stählen, Vergütungsstählen, Guss, Kupfer und Legierungen
- Bis 40 HRC zum Schruppen geeignet
- Auf Wunsch auch mit Beschichtung lieferbar

Solid carbide end mill for HSC milling in mould making

- Carbide grade: EZ 21
- Cutting to centre with 3 flutes
- Also well suited for the processing of steels, heat-treatable steels, cast iron, copper and alloys
- Up to 40 HRC suitable for roughing
- Can also be provided with coating if desired

Fraise à queue en carbure monobloc pour l'usinage HSC dans la fabrication de moules

- Sorte de métal dur: EZ 21
- Coupe au centre à trois dents
- Convient aussi bien pour l'usinage des aciers, aciers de traitement, fonte, cuivre et alliages
- Convient pour dégrossir jusqu'à 40 HRC
- Également avec revêtement sur demande

Bestell-Nr. order no N° référence	d ₁	l ₁	d	l
533.010	1,0	4,0	3,0	38
533.015	1,5	4,5	3,0	38
533.020	2,0	6,3	3,0	38
533.025	2,5	9,5	3,0	38
533.030	3,0	12,0	3,0	38
533.035	3,5	12,0	4,0	50
533.040	4,0	14,0	4,0	50
533.045	4,5	16,0	6,0	50
533.050	5,0	16,0	6,0	50
533.060	6,0	19,0	6,0	50
533.070	7,0	19,0	8,0	63
533.080	8,0	20,0	8,0	63
533.090	9,0	22,0	10,0	75
533.100	10,0	22,0	10,0	75
533.110	11,0	25,0	12,0	75
533.120	12,0	25,0	12,0	75



534

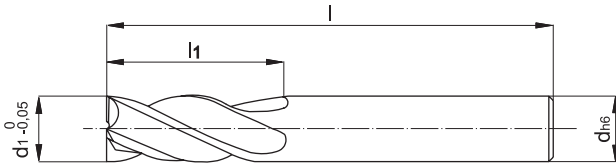

Bestell-Nr. order no N° référence	d ₁	l ₁	d	l
534.010	1,0	4,0	3,0	38
534.015	1,5	4,5	3,0	38
534.020	2,0	6,3	3,0	38
534.025	2,5	9,5	3,0	38
534.030	3,0	12,0	3,0	38
534.035	3,5	12,0	4,0	50
534.040	4,0	14,0	4,0	50
534.045	4,5	16,0	6,0	50
534.050	5,0	16,0	6,0	50
534.060	6,0	19,0	6,0	50
534.070	7,0	19,0	8,0	63
534.080	8,0	20,0	8,0	63
534.090	9,0	22,0	10,0	75
534.100	10,0	22,0	10,0	75
534.110	11,0	25,0	12,0	75
534.120	12,0	25,0	12,0	75

VHM-Schaftfräser für die HSC-Bearbeitung im Formenbau

- HM-Sorte: EZ 21
- Zentrumschneidend mit 4 Schneiden
- Auch gut geeignet zur Bearbeitung von Stählen, Vergütungsstählen, Guss, Kupfer und Legierungen
- Bis 40 HRC zum Schruppen geeignet
- Auf Wunsch auch mit Beschichtung lieferbar

Solid carbide end mill for HSC milling in mould making

- Carbide grade: EZ 21
- Cutting to centre with 4 flutes
- Also well suited for the processing of steels, heat-treatable steels, cast iron, copper and alloys
- Up to 40 HRC suitable for roughing
- Can also be provided with coating if desired

Fraise à queue en carbure monobloc pour l'usinage HSC dans la fabrication de moules

- Sorte de métal dur: EZ 21
- Coupe au centre à quatre dents
- Convient aussi bien pour l'usinage des aciers, aciers de traitement, fonte, cuivre et alliages
- Convient pour dégrossir jusqu'à 40 HRC
- Également avec revêtement sur demande

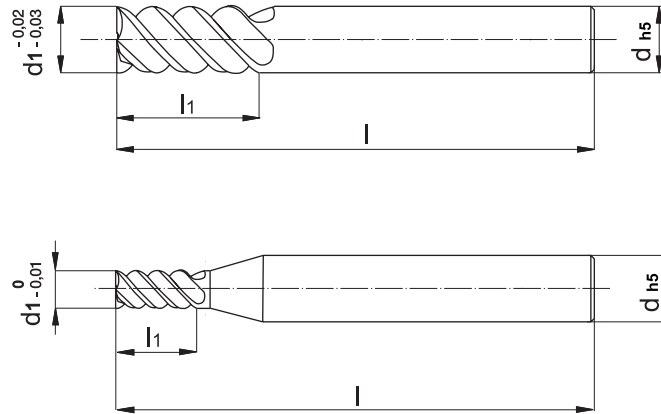
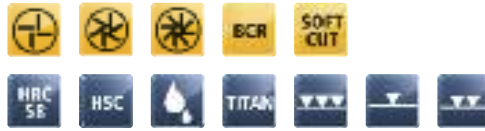

VHM-Schaftfräser für die HSC-Bearbeitung im Formenbau

- HM-Sorte: EZ 22
- Optimierte Beschichtung
- Zwei Schneiden zum Zentrum
- Auch gut geeignet zur Bearbeitung von Edelstahl, Guss, Kunststoffe, Titan
- Bis 45 HRC zum Schruppen geeignet

Solid carbide end mill for HSC milling in mould making

- Carbide grade: EZ 22
- Optimised coating
- Two flutes to the centre
- Also well suited for the processing of stainless steel, cast iron, plastics, titanium
- Up to 45 HRC suitable for roughing

Fraise à queue en carbure monobloc pour l'usinage HSC dans la fabrication de moules

- Sorte de métal dur: EZ 22
- Revêtement optimisé
- Deux dents à coupe au centre
- Convient aussi bien pour l'usinage de l'innox, la fonte, les plastiques, le titane
- Convient pour dégrossir jusqu'à 45 HRC

Bestell-Nr. order no N° référence	d_1	l_1	d	l	Zähne teeth dents
588.030	3,0	10,0	4,0	50	4
588.040	4,0	11,0	6,0	57	4
588.050	5,0	13,0	6,0	57	4
588.060	6,0	13,0	6,0	57	6
588.080	8,0	19,0	8,0	63	6
588.100	10,0	22,0	10,0	72	6
588.120	12,0	26,0	12,0	83	6
588.140	14,0	26,0	14,0	83	6
588.160	16,0	32,0	16,0	92	8
588.180	18,0	32,0	18,0	92	8
588.200	20,0	38,0	20,0	104	8

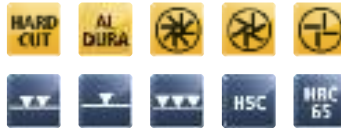

588H

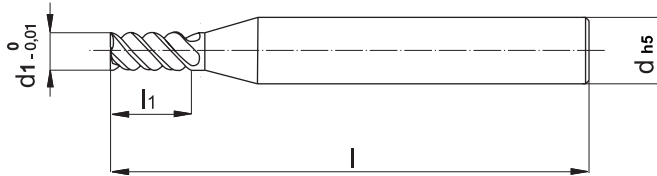
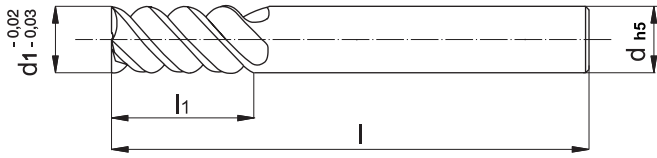

Bestell-Nr. order no N° référence	d ₁	l ₁	d	l	Zähne teeth dents
588H030	3,0	10,0	4,0	50	4
588H040	4,0	11,0	6,0	57	4
588H050	5,0	13,0	6,0	57	4
588H060	6,0	13,0	6,0	57	6
588H080	8,0	19,0	8,0	63	6
588H100	10,0	22,0	10,0	72	6
588H120	12,0	26,0	12,0	83	6
588H140	14,0	26,0	14,0	83	6
588H160	16,0	32,0	16,0	92	8
588H180	18,0	32,0	18,0	92	8
588H200	20,0	38,0	20,0	104	8

VHM-Schaftfräser für die HSC-Bearbeitung im Formenbau

- HM-Sorte: EZ 22
- Verstärkte Schneidengeometrie
- Zwei Schneiden zum Zentrum

Solid carbide end mill for HSC milling in mould making

- Carbide grade: EZ 22
- Reinforced flute geometry
- Two flutes to the centre

Fraise à queue en carbure monobloc pour l'usinage HSC dans la fabrication de moules

- Sorte de métal dur: EZ 22
- Géométrie renforcée des dents
- Deux dents à coupe au centre

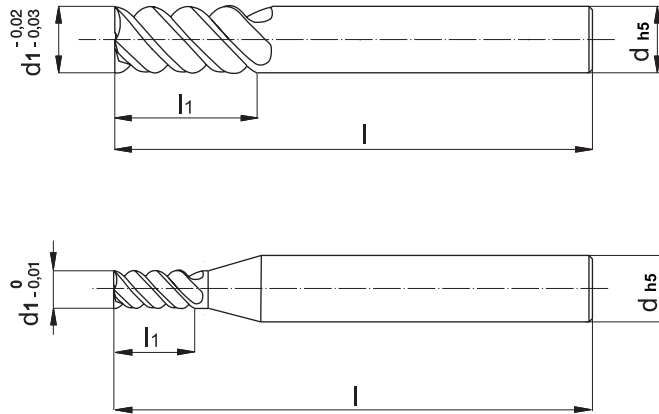
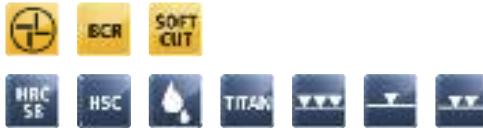

VHM-Schaftfräser für die HSC-Bearbeitung im Formenbau

- HM-Sorte: EZ 22
- Optimierte Beschichtung
- Zwei Schneiden zum Zentrum
- Auch gut geeignet zur Bearbeitung von Edelstahl, Guss, Kunststoffe, Titan
- Werkzeug mit großer Spankammer und stabilem Kern
- Dadurch gut geeignet zum Schruppen

Solid carbide end mill for HSC milling in mould making

- Carbide grade: EZ 22
- Optimised coating
- Two flutes to the centre
- Also well suited for the processing of stainless steel, cast iron, plastics, titanium
- Tool with large chipping spaces and robust core
- Making it well suited for roughing

Fraise à queue en carbure monobloc pour l'usinage HSC dans la fabrication de moules

- Sorte de métal dur: EZ 22
- Revêtement optimisé
- Deux dents à coupe au centre
- Convient aussi bien pour l'usinage de l'inox, la fonte, les plastiques, le titane
- Outil avec grand espace entre dents et noyau stable
- Qui convient donc bien pour dégrossir

Bestell-Nr. order no N° référence	d ₁	l ₁	d	l
589.030	3,0	10,0	6,0	60
589.040	4,0	12,0	6,0	60
589.050	5,0	13,0	6,0	60
589.060	6,0	15,0	6,0	60
589.080	8,0	20,0	8,0	80
589.100	10,0	25,0	10,0	80
589.120	12,0	30,0	12,0	100
589.160	16,0	40,0	16,0	110
589.200	20,0	45,0	20,0	130
589.250	25,0	60,0	25,0	150
589.320	32,0	85,0	32,0	165

Schnittdatenempfehlungen

Cutting data recommendations

Valeurs de coupe recommandées

Für einen schnellen und unkomplizierten Zugriff auf stets aktuelle Schnittdaten können Sie den Schnittdatenrechner auf unserer Homepage nutzen. Melden Sie sich dafür unter www.zecha.de an und Sie erhalten umgehend Ihre persönlichen Zugangsdaten per E-Mail.

Nun können Sie sich jederzeit über unsere Webseite in den Schnittdatenrechner einloggen und sofort alle relevanten Daten für Ihre Fräsanwendungen abrufen:

Produktdaten: Auswahl des Fräasers, zu bearbeitender Werkstoff, Härte des Werkstoffes, Bearbeitungsart, gewünschte Oberflächenqualität

Empfehlungen: Vc Schnittgeschwindigkeit, fz Vorschub pro Zahn, n Drehzahl, ap Zustelltiefe, Vf Vorschub mm/min, ae Eingrißbreite, zum Schruppen, Vorschlichten, Feingrißlichter, Standard oder HSC Schnittparameter

To always obtain quick and easy access to current cutting data use the cutting data calculator on our homepage. Apply for this service at www.zecha.de and you will immediately receive your personal log-on data per email.

You can now log on via our website into the cutting data calculator at any time and utilise all the relevant data for your milling applications immediately.

Product data: Selection of milling cutter, material to be processed, hardness of the material, type of processing, desired surface quality

Recommendations: Vc Cutting speed fz Feed per tooth, n Rpm, ap Feed travel, Vf Feed mm/min, ae Engagement width, for roughing, pre-finishing, finishing, standard or HSC cutting parameter

Pour un accès simple et rapide aux valeurs de coupe toujours actualisées, vous pouvez utiliser le calculateur de valeurs de coupe sur notre site Web. Il vous suffit pour cela de cliquer sur le site www.zecha.de et vous recevrez immédiatement vos identifiants de connexion personnels par e-mail.

Vous pouvez désormais vous connecter à tout moment à notre site Web pour utiliser le calculateur de valeurs de coupe et consulter toutes les données pertinentes pour vos applications de fraisage:

Données des produits: Choix de la fraise, matériau à usiner, dureté du matériau, genre d'usinage, qualité de surface désirée.

Recommandations: vc vitesse de coupe, fz avance par dent, n régime, ap étendue de réglage Vf avance mm/min, ae largeur de prise, à dégrossir, pré finition, finition, standard ou paramètre de coupe HSC



Die Funktionen im Überblick:

- Suche über Toolnavigator oder Werkzeugnummer direkt
- Empfohlene Schnittdaten für Schruppen, Vorschlichten, Feinschlichten, Standard oder HSC
- Drehzahlbezogene und vorschubbezogene alternative Schnittdaten

Overview of functions:

- Search via tool navigator or directly via tool number
- Recommended cutting data for roughing, pre-finishing, finishing, standard or HSC
- Rpm-related and feed-related alternative cutting data

Vue d'ensemble des fonctions:

- Recherche par Toolnavigator (navigateur d'outil) ou directement par le numéro d'outil
- Données de coupe recommandées pour le dégrossissage, la pré finition, la finition, la coupe standard ou HSC
- Valeurs de coupe alternatives en fonction du régime et de l'avance

Garantierte Qualität Quality warranty Qualité garantie

Qualitätssicherung

Zecha steht für Produkte, die höchsten Qualitätsanforderungen gerecht werden. Gemäß dem Anspruch unserer Kunden, ist das Qualitätsmanagement bei Zecha in allen Abläufen fest verankert und sichert damit ein gleichbleibend hohes Qualitätsniveau. Modernste Messgeräte in vollklimatisierten Räumen sichern dabei die Qualität unserer Produkte.



Quality assurance

Zecha manufactures products that meet the highest quality demands. As our customers expect, quality management is firmly embedded in all processes at Zecha and this ensures a consistent high level of quality. Ultramodern measuring instruments in fully air-conditioned rooms ensure the quality of our products.

Assurance de la qualité

Zecha est synonyme de produits qui remplissent les exigences de qualité les plus strictes. Conformément aux demandes de nos clients, chez Zecha la gestion de la qualité est profondément ancrée dans tous les procédés et garantit ainsi un niveau de qualité élevé et constant. Les instruments de mesure ultramodernes dans les locaux entièrement climatisés garantissent ainsi la qualité de nos produits.

Lebensnummer

Sämtliche Werkzeuge durchlaufen eine strenge Kontrolle, bei der alle relevanten Daten protokolliert werden. Die Identifikationsnummer des Werkzeugs wird zusammen mit der Produktionscharge per Laser auf dem Boden des Schafts graviert, sodass jedes Werkzeug eindeutig identifiziert und auch noch Jahre später präzise reproduziert werden kann.



ID number

All our tools undergo strict inspection in which all the relevant data is entered in a protocol. The identification number of the tool along with the production batch is engraved onto the base of the shaft by laser so that every tool can be individually identified and can be precisely reproduced years later.

Numéro à vie

Tous les outils sont soumis à des contrôles stricts, lors desquels toutes les données pertinentes sont enregistrées. Le numéro d'identification de l'outil est gravé au laser au bout de la queue avec le lot de production, afin que chaque outil puisse être identifié de manière claire et être reproduit avec précision bien des années plus tard.

Hartmetall

Unsere Hartmetalle beziehen wir ausschließlich von führenden Herstellern, um die gleichbleibend hohe Güte sicherzustellen. Ausgewählte Sorten bieten allerhöchste Qualität bezüglich Gefüge, Härte und Bruchfestigkeit und garantieren so eine metallurgische Konstanz.



Solid carbide

We procure our solid carbide solely from leading manufactures so as to ensure consistently high quality. Selected types offer the highest possible quality as regards structure, hardness and breaking strength and thus guarantee metallurgic consistency.

Métal dur

Nous nous procurons nos carbures exclusivement auprès de fabricants majeurs, afin de garantir une qualité élevée et constante. Les types sélectionnés sont inégalés en termes de structure, de dureté et de résistance à la rupture et garantissent ainsi une constance métallurgique.

BALINIT® ALDURA Beschichtung

Die Hochleistungsschicht BALINIT® ALDURA wurde von Oerlikon Balzers gezielt für VHM-Werkzeuge zum Schruppen und Schlichten gehärteter Stähle und schwer zerspanbarer Materialien entwickelt. Ein neuartiger, dualer Schichtaufbau vereint und optimiert die Stärken bewährter Schichtsysteme. Eine Kombination, die in der Hartzerspannung und in der Bearbeitung von schwer zerspanbaren Materialien völlig neue Leistungsbereiche erschließt.

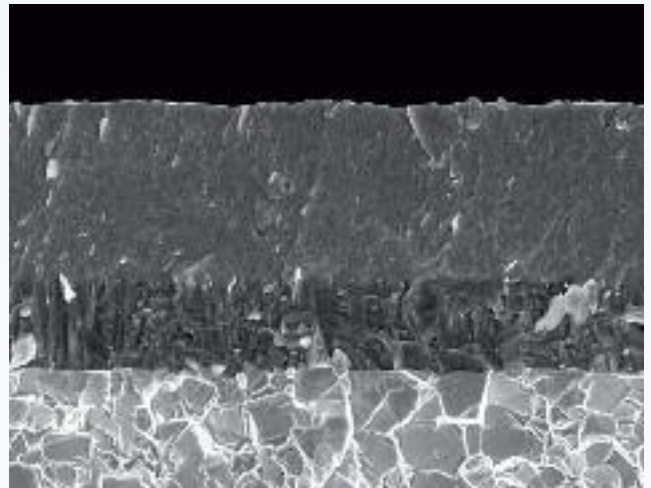

BALINIT® ALDURA coating

The high performance coat BALINIT® ALDURA was specially developed by Oerlikon Balzers for solid carbide tools in the roughing and finishing of hardened steels and materials difficult to machine. A novel, dual coat structure combines and optimises the strengths of the tried-and-tested coat systems. A combination that opens up completely new areas of performance for hard machining and in the processing of materials difficult to machine.

Revêtement BALINIT® ALDURA

La couche à haute performance BALINIT® ALDURA a été spécialement mise au point par Oerlikon Balzers pour des outils en carbure monobloc pour dégrossir et dresser les aciers trempés et les matériaux difficilement usinables. Une structure de couche duale d'un nouveau genre réunit et optimise les avantages des systèmes de revêtement éprouvés. Une combinaison qui ouvre de tout nouveaux domaines de performance dans l'usinage et la transformation de matériaux difficilement usinables.

Produktwelt Product world Univers de produits



Fräser für Graphit
Milling tools for graphite
Fraises pour graphite



Harte Werkstoffe
Hard materials
Matériaux durs



Harte Werkstoffe Q-Max
Hard materials Q-Max
Matériaux durs Q-Max



Stanzen & Umformen
Carbide blanking and forming tools
Outils de poinçonnage et d'emboutissage
en carbure



DIN/ISO Lochstempel und Buchsen
DIN/ISO punches and blanking sleeves
Poinçons et canons selon DIN/ISO



Mikrowerkzeuge
Micro-tools
Micro-outils



Werkzeuge Medizintechnik
Medical tools
Outils technique médicale



Fräser für TORX - Schrauben
End mills for TORX -screws
Fraises pour vis TORX



Gewindefräser für Implantate
Thread milling cutters for implants
Fraises à fileter pour implants



Dentalfräser
End mills for the dental industry
Fraises dentaires



Gewindewirbler für Dental Implantate
Whirl thread cutters for dental implants
Tourbillonneurs à fileter pour implants dentaires



CVD/PKD-Fräser mit Schneidkanten
CVD/PCD end mills with cutting edges
Fraises CVD/PCD avec arêtes de coupe



Spiralbohrer mit Innenkühlung
Spiral drills with internal coolant supply
Forets hélicoïdaux avec refroidissement interne



Spiralbohrer für anspruchsvolle Anwendungen
Spiral drills for demanding applications
Forets hélicoïdaux pour applications exigeantes

Viele weitere Produktlinien finden Sie unter
Many other products can be found at
Vous trouverez de nombreuses autres gammes de produits à l'adresse

www.zecha.de

Werkzeuge weltweit im Einsatz

Tools in global use

Des outils utilisés dans le monde entier



Allgemeine Hinweise

General instructions

Consignes générales

Dieser Katalog ist urheberrechtlich geschützt. Die Vervielfältigung von Informationen oder Daten, insbesondere die Verwendung von Texten, Textteilen oder Bildmaterial, bedarf der vorherigen Zustimmung der Zecha Hartmetall-Werkzeugfabrikation GmbH.

Technische Änderungen unserer Produkte und Änderungen des Lieferprogrammes im Zuge der Weiterentwicklung behalten wir uns vor.

Unsere Allgemeinen Geschäftsbedingungen finden Sie auch im Internet unter:
<http://www.zecha.de/agb>

Quellennachweis:
Werkstück: Titel, Seite 3:
exeron GmbH
Bild: Seite 2, Seite 55:
Oerlikon Balzers

This catalogue is protected by copyright. The reproduction of information or data, in particular the use of texts, text excerpts or images requires the express prior permission of Zecha Hartmetall-Werkzeugfabrikation GmbH.

We reserve the right to make technical changes or alter the delivery range as a result of further development.

Our General Terms and Conditions of Business can also be found in the internet:
<http://www.zecha.de/agb>

Source:
Component: title page, page 3:
exeron GmbH
Picture: Page 2, page 55:
Oerlikon Balzers

Ce catalogue est protégé par des droits d'auteur. Toute reproduction des informations ou données, en particulier l'utilisation de textes, parties de texte ou matériel d'illustration, requiert l'accord préalable de la société Zecha Hartmetall-Werkzeugfabrikation GmbH.

Sous réserve de modifications techniques de nos produits et modifications du programme de livraison dans le cadre du développement permanent.

Vous trouverez également nos conditions générales de vente sur notre site Internet à l'adresse: <http://www.zecha.de/agb>

Sources:
Pièce à usiner: Page de titre, page 3:
exeron GmbH
Photo: Page 2, page 55:
Oerlikon Balzers



www.zecha.de

ZECHA Hartmetall-
Werkzeugfabrikation GmbH
Benzstr. 2
D-75203 Königsbach-Stein

Tel. +49 (0) 72 32 / 30 22-0
Fax +49 (0) 72 32 / 30 22-25

info@zecha.de
www.zecha.de

